

EMC TEST REPORT

Company Name: ME Lighting (UK) Limited

Product: ME-T5-49W

Test Report Number	ETS/Q1657/EN
Issue Date:	08 August 2011
Applicable Standards	EN55015:2006 + A1:2007 EN55022:2006 + A1:2007 Class B EN61000-3-2:2006 + A2:2009 EN61000-3-3:2008 EN61547:1996 + A1:2000
Pursuant to	EMC Directive 2004/108/EC

Revision Record

Revision	Date	Details
1.0	08.08.2011	Issue Version 1

Note:

This Test Report consists of 73 pages. This report records the test results of the equipment submitted and does not imply conformance of the equipment manufactured. This report is issued in Adobe Acrobat document format (PDF). The report shall not be reproduced except in full, without the written approval of Electromagnetic Testing Services Limited.

		Page
1.0	Contents	3
2.0	Summary	4
3.0	Introduction	5
4.0	Equipment Under Test (EUT)	6
	Identification of Apparatus Description of Apparatus Intended Use of Apparatus Location of Apparatus Description of Variants Declared EUT Configuration Declared Suppression Measures Declared Internal Clock Frequencies	
5.0	Deviations From Standards	9
6.0	EUT Test Configuration	10
7.0	Test Plan	11
8.0	Test Results - Emissions	17
	Conducted Emissions Radiated Emissions Harmonic Current Voltage Fluctuation & Flicker Inrush Current	
9.0	Conclusions - Emissions	34
10.0	EUT Performance Assessment	35
11.0	Test Results - Immunity	36
	Electrostatic Discharge (ESD) RF Radiated Field Immunity Fast Transients/Burst Immunity Surge Immunity Test Conducted Immunity Magnetic Field Immunity Voltage Dips/Interruptions	
12.0	Conclusions - Immunity	44
13.0	Appendix	45

Electromagnetic emissions and immunity tests were carried out on a ME-T5-49W, to assess compliance against the requirements of:

EN55015:2006 + A1:2007, EN55022:2006 + A1:2007 Class B, EN61000-3-2:2006 + A2:2009, EN61000-3-3:2008 (emissions)

EN61547:1996 + A1:2000 (immunity)

The results obtained indicate compliance with the test limits of the above standards as follows:

Emissions Tests		Standard	Status
Emissions Standard for Lighting Equipment		EN55015:2006 + A1:2007	Complied
Conducted Emissions AC Port	*	EN55015:2006 + A1:2007	Complied with a minimum margin of -25.72 dBuV
Radiated Emissions (Magnetic Field)	*	EN55015:2006 + A1:2007	Complied with a minimum margin of - 49.97 dBuV
Radiated Emissions (Electric Field)	*	EN55022:2006 + A1:2007 Class B	Complied with a minimum margin of - 14.53 dBuV/m
Harmonic Current Emissions		EN61000-3-2:2006 + A2:2009	Complied (99.76 % of the limit)
Voltage Fluctuation & Flicker		EN61000-3-3:2008	Complied
Inrush Current		EN61000-3-3:2008	Complied (0.570 A)

Immunity Tests		Standard	Status
Immunity standard for Lighting Equipment		EN61547:1996 +A1:2000	Complied
Electrostatic Discharge	*	EN61000-4-2:1995	Complied
Radiated Immunity		EN61000-4-3:2006	Complied
Fast Transient Bursts	*	EN61000-4-4:1995	Complied
Surges	*	EN61000-4-5:1995	Complied
Conducted Immunity		EN61000-4-6:2007	Complied
Magnetic Field Immunity	*	EN61000-4-8:1993	Complied
Voltage Dips	*	EN61000-4-11:1994	Complied
Voltage Interruptions	*	EN61000-4-11:1994	Complied

* UKAS Accredited Tests

The ME-T5-49W, is a T5 Conversion Kit system, which is used to allow the use of energy T5 lamps in T8 and T12 light fittings..

The model tested was a ME-T5-49W.

The test results contained in this report refer to the product (s) supplied for testing.

The EUT was received on 10 June 2011. All tests were carried out between 15 June and 04 July 2011 at the Electromagnetic Testing Services Limited EMC Facilities, Stebbing, Essex, England. The work was carried out under ETS Test Number 06A11Q116.

The EUT was tested under normal laboratory conditions.

No representative from ME Lighting (UK) Limited, was present during testing.

4.1 Identification of Equipment

Nomenclature / Product Type : T5 conversion kit

Brand Name : ME-T5

Model Number : ME-T5-49W

Serial Number : EMC Unit

Power Requirements : 240 V 50 Hz 49 W

Manufacturer Name : ME Lighting (UK) Ltd

Manufacturer Address : The Fifth Floor,
The Wheatsheaf, Speirs Wharf,
Port Dundas, Glasgow, G4 9TJ

Signatory's Name : Mr Chris Knight

Signatory's Address : The Fifth Floor,
The Wheatsheaf, Speirs Wharf,
Port Dundas, Glasgow, G4 9TJ

Photograph of EUT



- 4.2 Description of Apparatus:** The ME-T5 adaptor kit consists of four or five components, subject to the type of installation being carried out. The components are as follows:

- Main body of the adaptor – attached to the T5 tube
- Spacer – attached to the opposite end of the tube
- Replacement for the T8 or T12, starter
- An EMC filter, either fitted within the fitting, or at the lighting breaker board
- A harmonics filter – which is required when there is not an electromagnetic ballast in the luminaire

The above components should be used, in conjunction with the removal of the power factor correction capacitor from the luminaire – if present.

- 4.3 Intended Use of Apparatus:** To allow the use of energy efficient T5 lamps in T8 and T12 light fittings
- 4.4 Intended Physical Location of EUT:** Domestic, Commercial and industrial
- 4.5 Description of Variants:** None

4.6 Declared EUT Configuration:

Item	Description of board/sub assemblies	Part Number	Revision No.

4.7 Declared Suppression Measures:

The following modifications were applied to the EUT in order to achieve compliance
 Warning: Compliance is subject to the correct application of all listed modifications

Mod Status	Description of Suppression Measures	Reason	Date & Time
0	EUT as supplied with no additional modifications		

4.8 Declared Internal Clock Frequencies:

ELECTROMAGNETIC TESTING SERVICES LIMITED

EUT: T5 CONVERSION KIT, ME-T5-49W

COMPANY: ME LIGHTING (UK) LIMITED

TITLE OF SECTION: **DEVIATIONS FROM TEST SPECIFICATION**

TEST REPORT NO: ETS/Q1657/EN

PAGE: 9 OF 73

ISSUE DATE: 08 AUGUST 2011

SECTION: 5.0

5.0 Deviations From Applicable Standards

None

Block Diagram

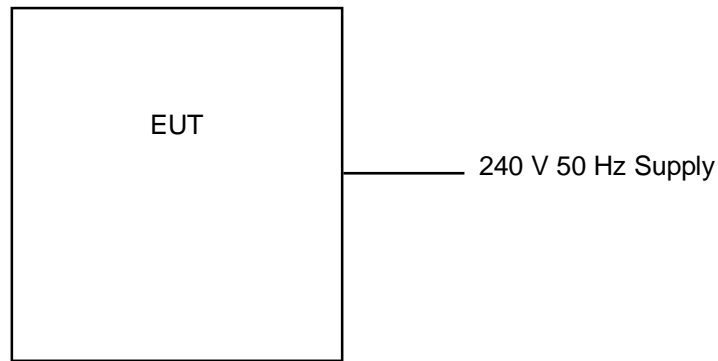

LIST OF CABLES

Ref.	Cable	Type	Length / m
1	Mains Power cable	3 core unscreened	1.5
2			
3			
4			



Test Plan and check list Reference EN55015:2006 + A1:2007 & EN61547:1996 + A1:2000 (template issue 006)

Test number: **06A11Q116** Customer: **Mission Environmental Limited**
 Date: **14 June 2011** EUT: **6 Ft 49W with MEL Adaptor**

N.B. use this document together with the "Test Questionnaire". In the following check list enter a tick in the space provided against each test to be carried out as agreed with the customer. Reasons for not carrying out tests shall be recorded. For this purpose a reference number shall be entered against the relevant space on the check list. The reason shall be recorded on the final page of this document with the appropriate reference number. Detail of each cable (port) tested for immunity shall be recorded (additional spaces are provided).

Port tested	Standard & Emission phenomenon	Test value	Class required	
			Class required	Test required
Radiated Emission (E) Measured in SAR				
Enclosure	EN55022:2006 + A1:2007	30MHz to 300 MHz	B	X
	FCC part 15	(As required)		
Radiated Emission (E) Measured on OATS				
Enclosure	EN55022:2006 + A1:2007	30MHz to 300 MHz	B	X
	FCC part 15	(As required)		
Radiated Emission (H)				
Enclosure	EN55015:2006 + A1:2007	9kHz to 30MHz	Tbl 3a	X
	FCC part 15	(As required)		
Conducted Emission				
AC mains	EN55015:2006 + A1:2007	9kHz to 30MHz	Tbl 2a	X
	FCC part 15	(As required)		
Conducted Emission				
Load Terminals	EN55015:2006 + A1:2007	150kHz to 30MHz	Tbl 2b	1
Conducted Emission				
Control Terminals	EN55015:2006 + A1:2007	150kHz to 1605MHz	Tbl 1	2

* Test marked with '*' will be carried out in conjunction with other units.

Port tested	Standard & Emission phenomenon	Test value	Test results	
			Class required	Test required
Harmonics				
AC mains	EN61000-3-2:2006 + A2:2009	0Hz - 0.002 MHz (specified power <600W)	C	X
Flicker				
AC mains	EN61000-3-3:2008	< 1 P _{st}	←	X
	EN61000-3-3:2008	< 0.65 P _{lt}	←	
	EN61000-3-3:2008	< 3.3% d _c	←	
	EN61000-3-3:2008	< 4% d _{max}	←	
	EN61000-3-3:2008	< 3.3% 500mS d _t	←	
Inrush Current				
AC mains	(EN61000-3-3:2008)	Measured result:		X

Performance criterion for immunity testing may be summarised as follows:

- A. EUT operates as intended within specification with no degradation of performance or loss of function.
- B. No degradation of performance or loss of function after application of the phenomena below specification limits.
- C. Degradation of performance or loss of function which is self-recoverable or can be restarted by operation of controls.

Port tested	Standard & Immunity phenomenon	Test value	Performance criteria required	Test required
Electromagnetic				
Enclosure	EN61000-4-3:2006	3V/m (80% 1kHz) 80MHz – 1.0GHz	A	X
Conducted RF				
AC Power	EN61000-4-6:2007	3V (80% 1kHz) 150kHz – 80MHz	A	X
Conducted RF				
DC Power	EN61000-4-6:2007	3V (80% 1kHz) 150kHz – 80MHz	A	3
I/O Signal & Control Conducted RF				
	EN61000-4-6:2007	lines >3m 3V (80% 1kHz) 150kHz–80MHz	A	4
	EN61000-4-6:2007	lines >3m 3V (80% 1kHz) 150kHz–80MHz	A	
	EN61000-4-6:2007	lines >3m 3V (80% 1kHz) 150kHz–80MHz	A	
Voltage Dips and Interrupts				
AC Power ¹	EN61000-4-11:1994	240 VAC 200mS (50Hz) 30%	C	X
	EN61000-4-11:1994	240 VAC 10 mS (50Hz) 100%	B	
	EN61000-4-11:1994	100 VAC 200mS (50Hz) 30%	B	
	EN61000-4-11:1994	100 VAC 10 mS (50Hz) 100%	C	

Port tested	Standard & Immunity phenomenon	Test value	Performance criteria required	Test required
Power frequency magnetic field				
Enclosure	EN61000-4-8:1993	3 A/m (r.m.s) at 50Hz Applicable only to equipment containing susceptible devices	A	X
Fast transient burst				
AC Power ²	EN61000-4-4:1995 Min test	1kV	B	X
AC Power	EN61000-4-4:1995 Max test	1kV	B	
Fast transient burst				
DC Power	EN61000-4-4:1995	0.5kV	B	3
<i>i/o</i> Signal and Control Fast transient burst				
	EN61000-4-4:1995	0.5kV lines >3m	B	4
	EN61000-4-4:1995	0.5kV lines >3m	B	
AC Power Surge				
	EN61000-4-5:1995+A1+A2	1kV L-L 2kV L-E 20 / 60 s ⁴	C/B	X
	EN61000-4-5:1995+A1+A2	0.5kV L-L 1.0kV L-E 20 / 60 s ⁴	C/B	
	EN61000-4-5:1995+A1+A2	0.5kV L-L 1.0kV L-E 20 / 60 s ⁴	C/B	
AC Power (MLTV) ³	EN61000-4-5:1995+A1+A2	20 / 60 s ⁴		
ESD				
Enclosure	EN61000-4-2:1995+A1+A2	4kV contact 8kV air	B	X

Operating Mode

During testing the EUT was powered up and operated in accordance with the manufacture's instructions and in a manner that represented its normal use.

The EUT was monitored in the following operating modes as per the customer's instructions:

Performance Criteria

The EUT was assessed against the following performance criteria specified by the customer:

Notes

1

The Voltage Dips include testing at 240 V. For products with universal voltage power supplies, EN61000-4-11 requires that testing is also carried out at the lowest specified voltage. If the products will be sold exclusively in a 240 V / 220 V market, then, on request of the customer, the lower voltage test can be omitted and a 'Deviation from Standard' will be recorded in the test report.

2

Fast Transient testing can be applied as a minimum or maximum test, as follows:

Minimum - the fast transient bursts are applied common mode.

Maximum - the fast transient bursts are applied individually to the supply terminals and includes all possible combinations for a more complete test.

3

EN61000-4-5 advises that additional surge testing to be carried out at the Protection Devices Maximum Let Through Voltage Level. This could be a worst case testing of the EUT since the surge is applied at a level just before breakdown is initiated. This test is optional and carried out at the customers request.

4

EN61000-4-5 specifies surges to be applied with an interval of 60 seconds which allows protection devices cooling time between surges. Test times can be reduced by applying an interval of 20 seconds which is considered to be a more stringent test than the standard requires. This however, could cause systems to fail / get damaged that could have passed if the test was carried out at 60 seconds. Being aware of these possibilities customers can specify testing to be carried out with a 20 second interval, hence reducing test time. If testing at 20 second intervals cause failures and testing at 60 seconds do not, the test results at 60 second intervals prevails.

8.1 Conducted Emissions Results - AC Port

TEST STANDARD : EN55022:2006 + A1:2007

TEST SPECIFICATION : ETS tpCE

The powerline conducted emissions automatic scans are tabulated below.

Plot No.	Test File	Detector	Conductor	Frequency (MHz)	Level (dBuV)	Margin (dBuV)	Result
Plot 1a	Q116CAL1	Average	Live	24.0045	24.28	-25.72	Passed
Plot 1b	Q116CAN1	Average	Neutral	24.0045	20.35	-29.65	Passed
Plot 1c	Q116CQL1	Quasi Peak	Live	0.092	51.08	-33.37	Passed
Plot 1d	Q116CQN1	Quasi Peak	Neutral	0.0105	77.91	-32.09	Passed

The AC Port results plots illustrate the emissions from the EUT on the live and neutral conductors. These results can be compared directly with the EN55022:2006 + A1:2007 Class B limit line shown on the plot.

As it can be seen from plots 1a to 1d, all the emission levels from the EUT were below the Class B limit line. The narrowest compliance margin was -25.72 dBuV at 24.0045 MHz where the measured level was 24.28 dBuV.

The EUT achieved compliance as per case A, where the measured results are below the specified limit by a margin greater than the measurement uncertainty (see Appendix Section).

EUT Temp:	24 °C	%RH	51 %	Pa:	997 mB	Tested by:	GV	Date:	16/06/2011
------------------	-------	------------	------	------------	--------	-------------------	----	--------------	------------

Plot 1a - Q116CAL1 - Average Measurement - Live Port

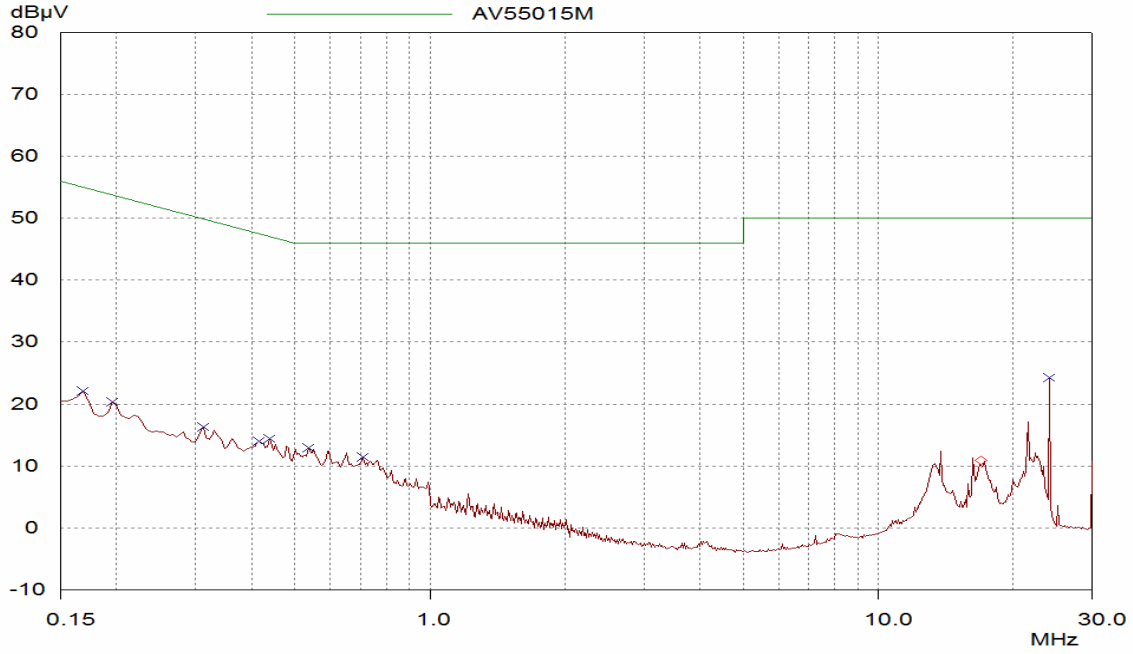

Frequency MHz	Level dBµV/m	Limit dBµV/m	QP Delta dB		
24.0045	24.28	50.00	25.72	L1	gnd
0.168	22.11	55.06	32.95	L1	gnd
0.195	20.30	53.82	33.52	L1	gnd
0.312	16.27	49.92	33.65	L1	gnd
0.438	14.43	47.10	32.67	L1	gnd
0.4155	13.99	47.54	33.55	L1	gnd
0.537	13.00	46.00	33.00	L1	gnd
0.708	11.48	46.00	34.52	L1	gnd

Plot 1b - Q116CAN1- Average Measurement - Neutral Port

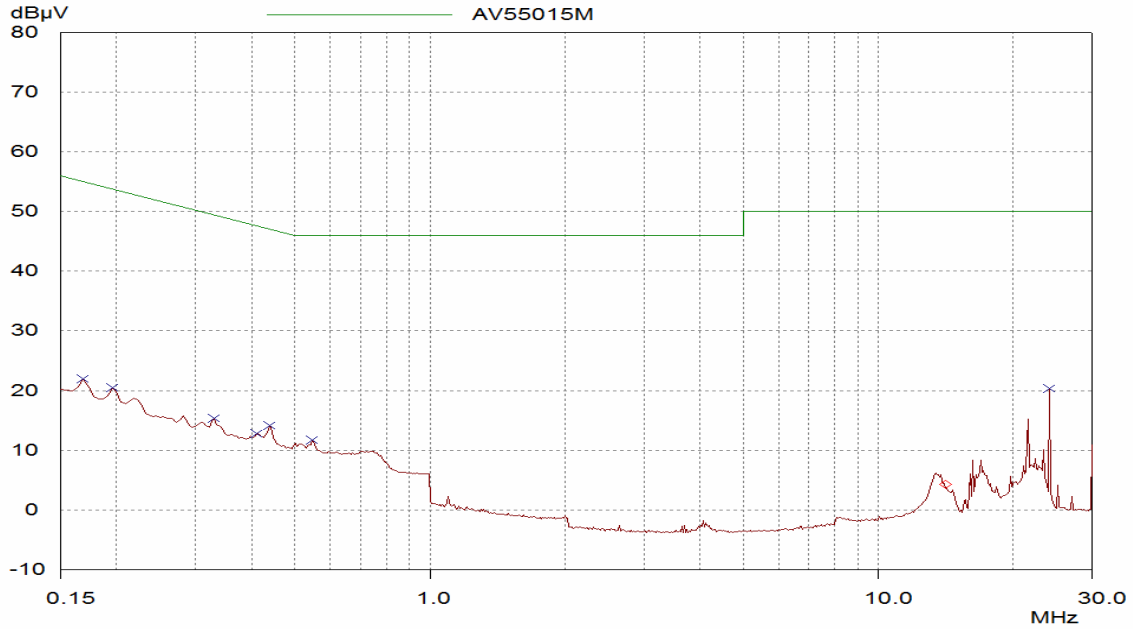

Frequency MHz	Level dBµV/m	Limit dBµV/m	QP Delta dB		
0.168	21.92	55.06	33.14	N	gnd
0.195	20.50	53.82	33.32	N	gnd
24.0045	20.35	50.00	29.65	N	gnd
0.33	15.33	49.45	34.12	N	gnd
0.438	14.12	47.10	32.98	N	gnd
0.411	12.81	47.63	34.82	N	gnd
0.546	11.72	46.00	34.28	N	gnd

Plot 1c - Q116CQL1 - Quasi Peak Measurement - Live Port

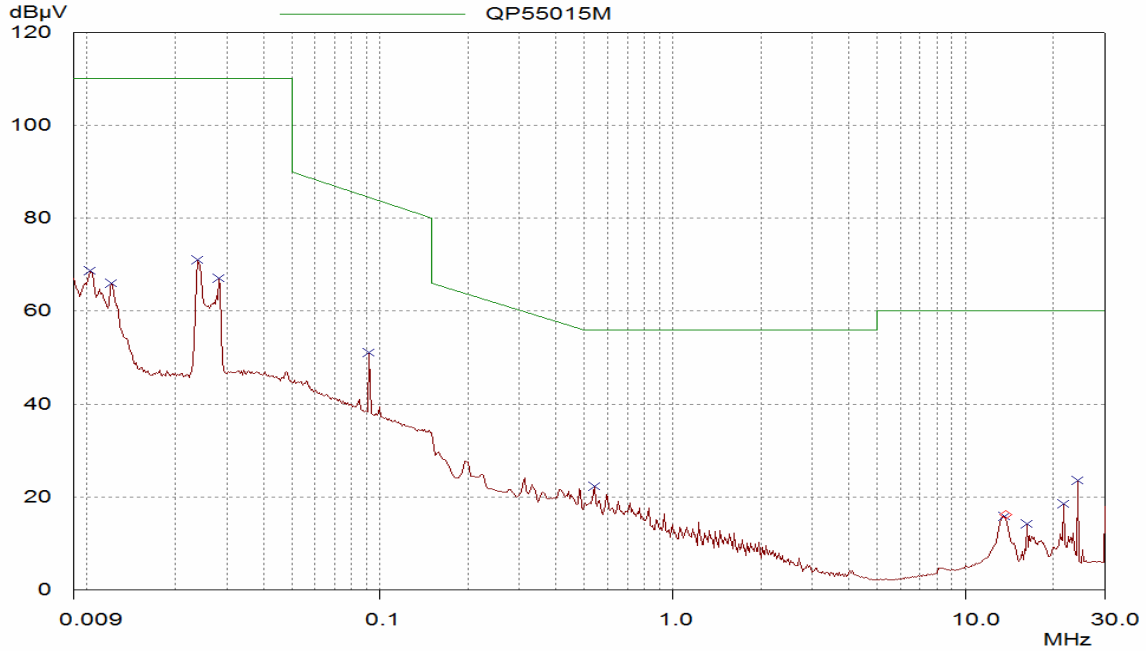

Frequency MHz	Level dBµV/m	Limit dBµV/m	QP Delta dB		
0.0239	71.11	110.00	38.89	L1	gnd
0.0102	68.63	110.00	41.37	L1	gnd
0.0281	67.06	110.00	42.94	L1	gnd
0.0121	65.92	110.00	44.08	L1	gnd
0.092	51.08	84.45	33.37	L1	gnd
24.0045	23.49	60.00	36.51	L1	gnd
0.537	22.31	56.00	33.69	L1	gnd
21.48	18.48	60.00	41.52	L1	gnd
13.5195	15.88	60.00	44.12	L1	gnd
16.2285	14.24	60.00	45.76	L1	gnd

Plot 1d - Q116CQN1 - Quasi Peak Measurement - Neutral Port

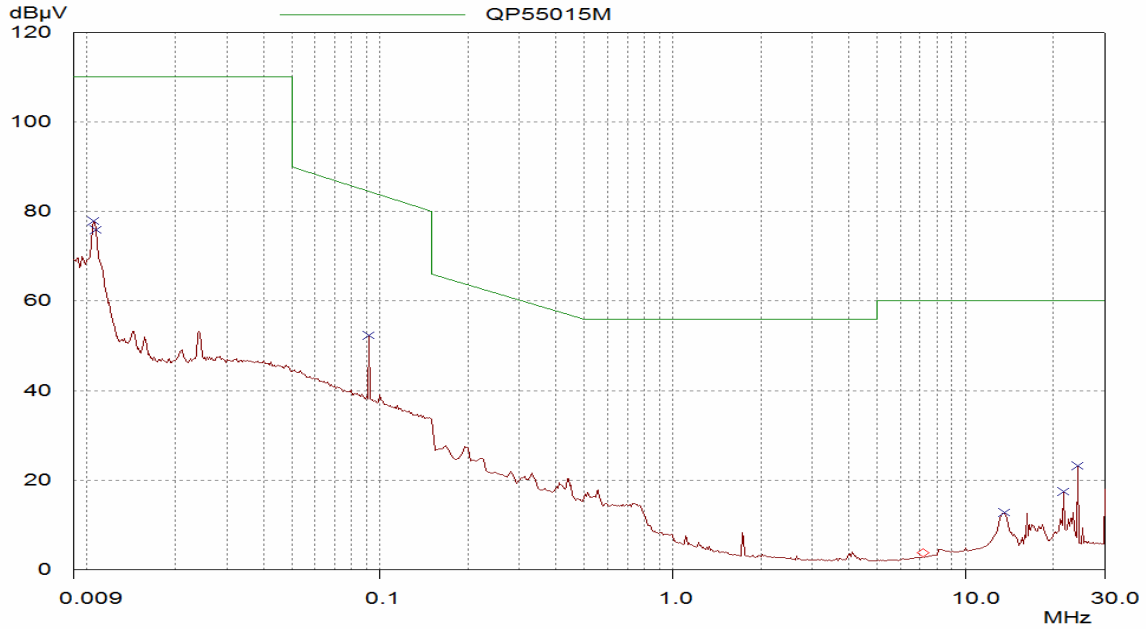

Frequency MHz	Level dBuV/m	Limit dBuV/m	QP Delta dB		
0.0105	77.91	110.0032.09		N	gnd
0.0107	75.86	110.0034.14		N	gnd
0.0917	52.27	84.48	32.21	N	gnd
24.0045	23.23	60.00	36.77	N	gnd
21.48	17.50	60.00	42.50	N	gnd
13.506	12.86	60.00	47.14	N	gnd

8.2 Radiated Emissions Results (Electric Field)

TEST STANDARD : EN55022:2006 + A1:2007
 TEST SPECIFICATION : ETS tpRE and ETS tpOATS

Plot No.	Test File	Frequency	Polarisation	Detector	Frequency (MHz)	Level (dBuV/m)	Margin (dBuV/m)	Result
Plot 2a	Q116RV1L	30 MHz to 300 MHz	Vertical	QP	162.0	15.13	-14.87	Passed
Plot 2b	Q116RH1L	30 MHz to 300 MHz	Horizontal	QP	160.02	15.47	-14.53	Passed

On all of the result plots the black trace represents the ambient noise and the red trace the emissions from the equipment under test (EUT). The green line illustrates the EN55022:2006 + A1:2007 Class B limit.

Emissions marked by ' X ' represent the maximised significant emissions from the EUT.

As it can be seen from plots 2a to 2b, all the emission levels from the EUT were below the class B limit line. The narrowest compliance margin was -14.53 dBuV/m at 160.02 MHz where the measured level was 15.47 dBuV/m.

The EUT achieved compliance as per case A, where the measured results are below the specified limit by a margin greater than the measurement uncertainty (see Appendix Section).

EUT Temp:	22 °C	%RH	54 %	Pa:	998 mB	Tested by:	GV / TK	Date:	07/07/2011
------------------	-------	------------	------	------------	--------	-------------------	---------	--------------	------------

Plot 2a Q116RV1L
 16 Jun 2011 16:26
 ELECTROMAGNETIC TESTING SERVICES LTD
 Electric Field Radiated Emissions Test - Vertical Polarisation
 ME Lighting (UK) Ltd - 49W 6ft with MEL adaptor

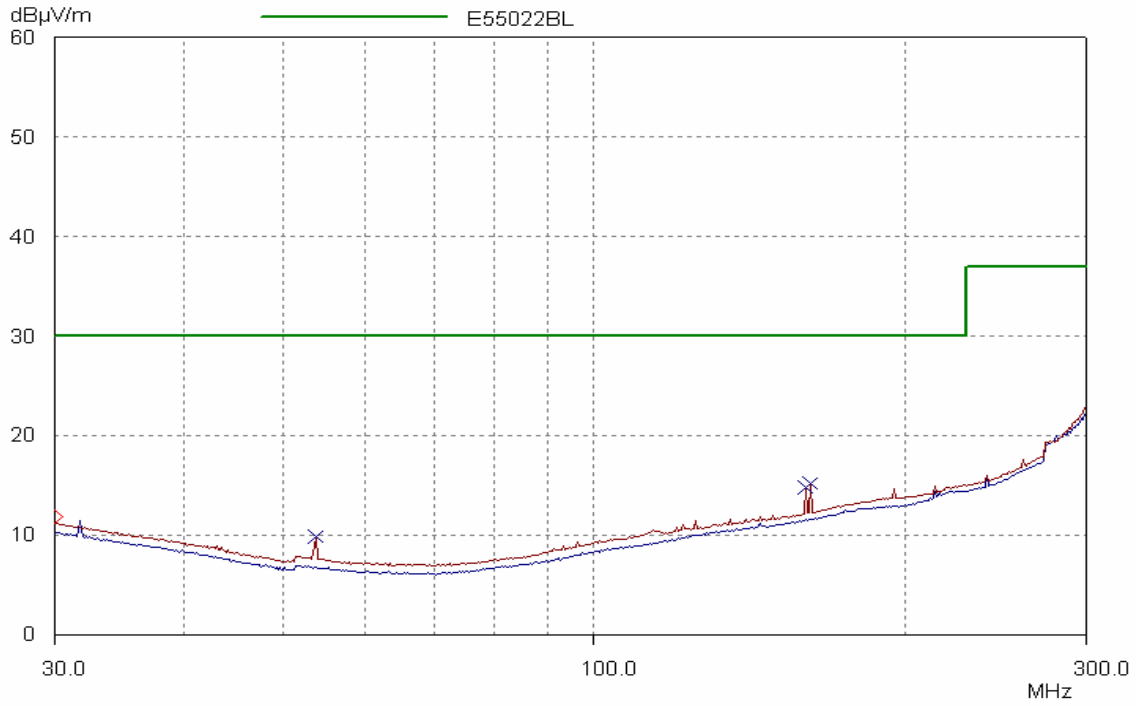

Frequency MHz	Level dBuV/m	Limit dBuV/m	Margin dBuV/m
162.0	15.13	30.00	14.87 -3.62
160.02	14.75	30.00	15.25 -3.11
53.65	9.90	30.00	20.10 -3.16

Plot 2b Q116RH1L
 16 Jun 2011 15:50
 ELECTROMAGNETIC TESTING SERVICES LTD
 Electric Field Radiated Emissions Test - Horizontal Polarisation
 ME Lighting (UK) Ltd - 49W 6ft with MEL adaptor

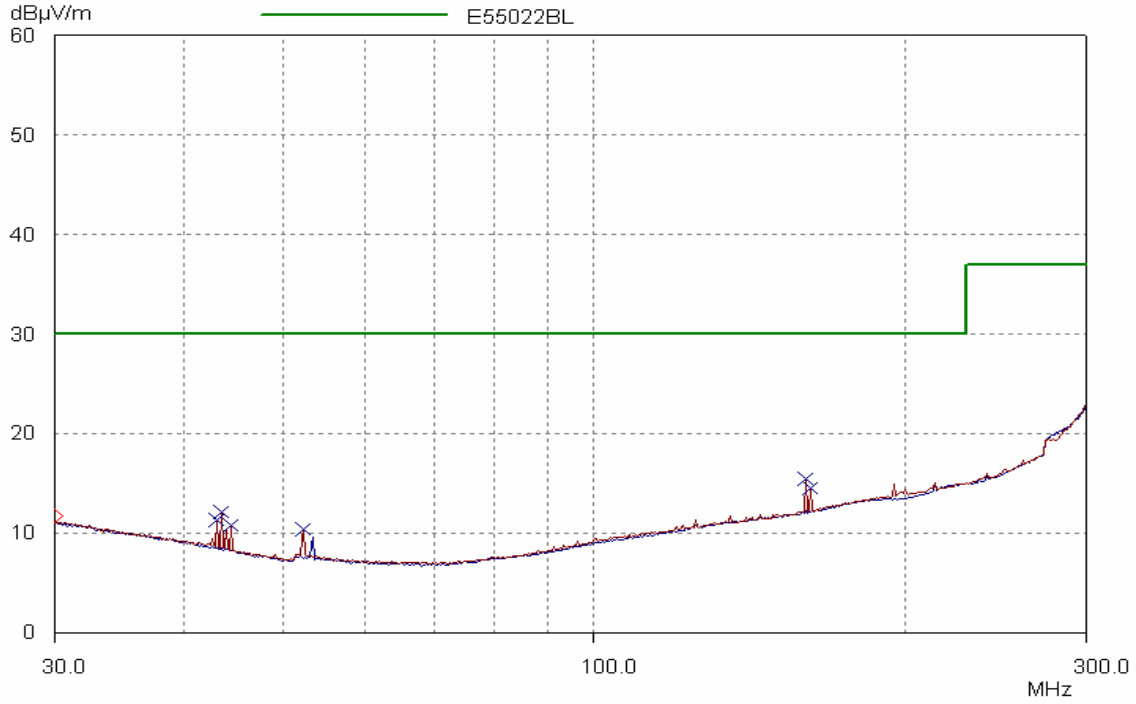

Frequency MHz	Level dBuV/m	Limit dBuV/m	Margin dBuV/m
160.02	15.47	30.00	14.53 -3.28
162.0	14.55	30.00	15.45 -2.49
43.53	12.13	30.00	17.87 -3.67
43.09	11.35	30.00	18.65 -2.90
44.41	10.76	30.00	19.24 -2.58
52.22	10.39	30.00	19.61 -2.90

8.2 Radiated Emissions Results (Magnetic Field)

TEST STANDARD : EN55015:2006 + A1:2007

Plot No.	Test File	Frequency	Polarisation	Detector	Frequency (MHz)	Level (dBuA)	Margin (dBuA)	Result
Plot 2c	Q116RM1X	9 kHz to 30 MHz	X	QP	0.168	-8.06	-64.70	Passed
Plot 2d	Q116RM1Y	9 kHz to 30 MHz	Y	QP	0.1635	6.99	-49.97	Passed
Plot 2e	Q116RM1Z	9 kHz to 30 MHz	Z	QP	9.5955	-35.11	-57.11	Passed

On all of the result plots the black trace represents the ambient noise and the red trace the emissions from the equipment under test (EUT). The green line illustrates the EN55015:2006 + A1:2007 limit.

Emissions marked by ' X ' represent the maximised significant emissions from the EUT.

As it can be seen from plots 2c to 2e, all the emission levels from the EUT were below the limit line. The narrowest compliance margin was -49.97 dBuA at 0.1635 MHz where the measured level was 6.99 dBuA.

The EUT achieved compliance as per case A, where the measured results are below the specified limit by a margin greater than the measurement uncertainty (see Appendix Section).

EUT Temp:	22 °C	%RH	54 %	Pa:	998 mB	Tested by:	GV / TK	Date:	07/07/2011
------------------	-------	------------	------	------------	--------	-------------------	---------	--------------	------------

Plot 2c Q116RM1X

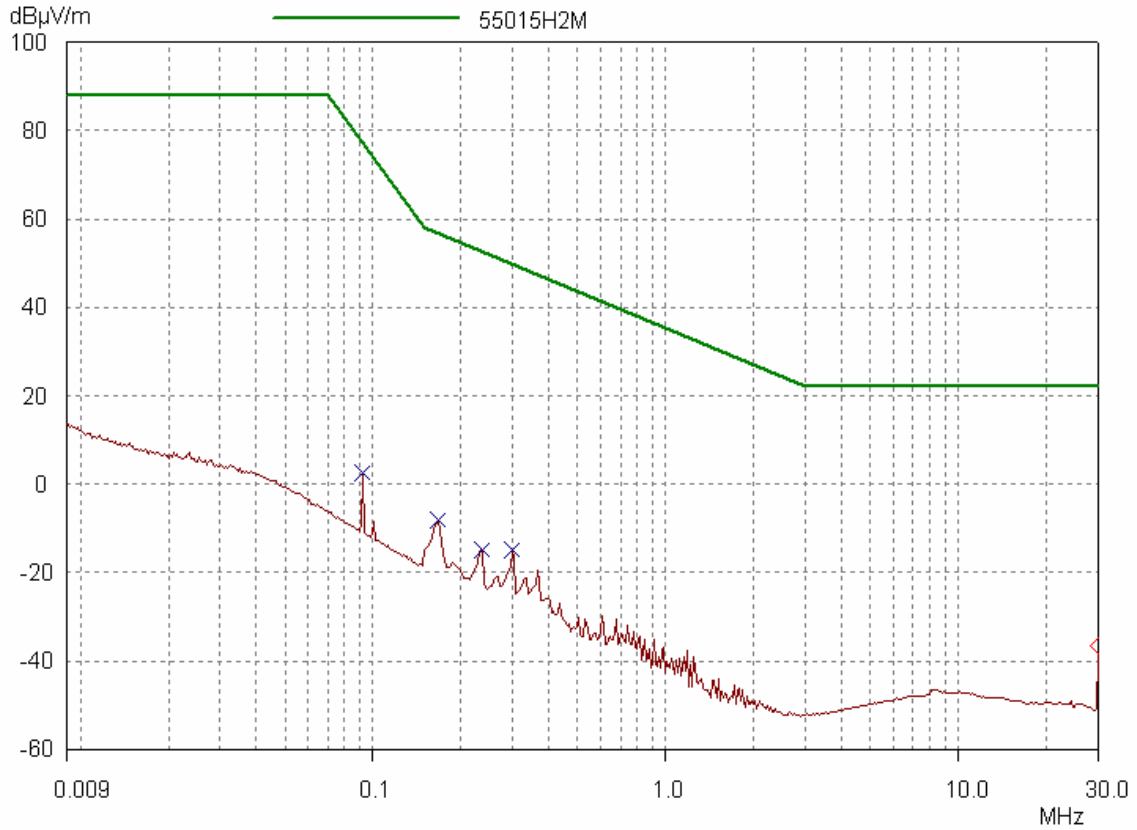

Frequency MHz	Level dBuV/m	Limit dBuV/m	Margin dBuV/m
0.0917	2.51	77.37	74.86
0.168	-8.06	56.64	64.70
0.2355	-14.95	52.58	67.53
0.2985	-15.02	49.73	64.75

Plot 2d Q116RM1Y

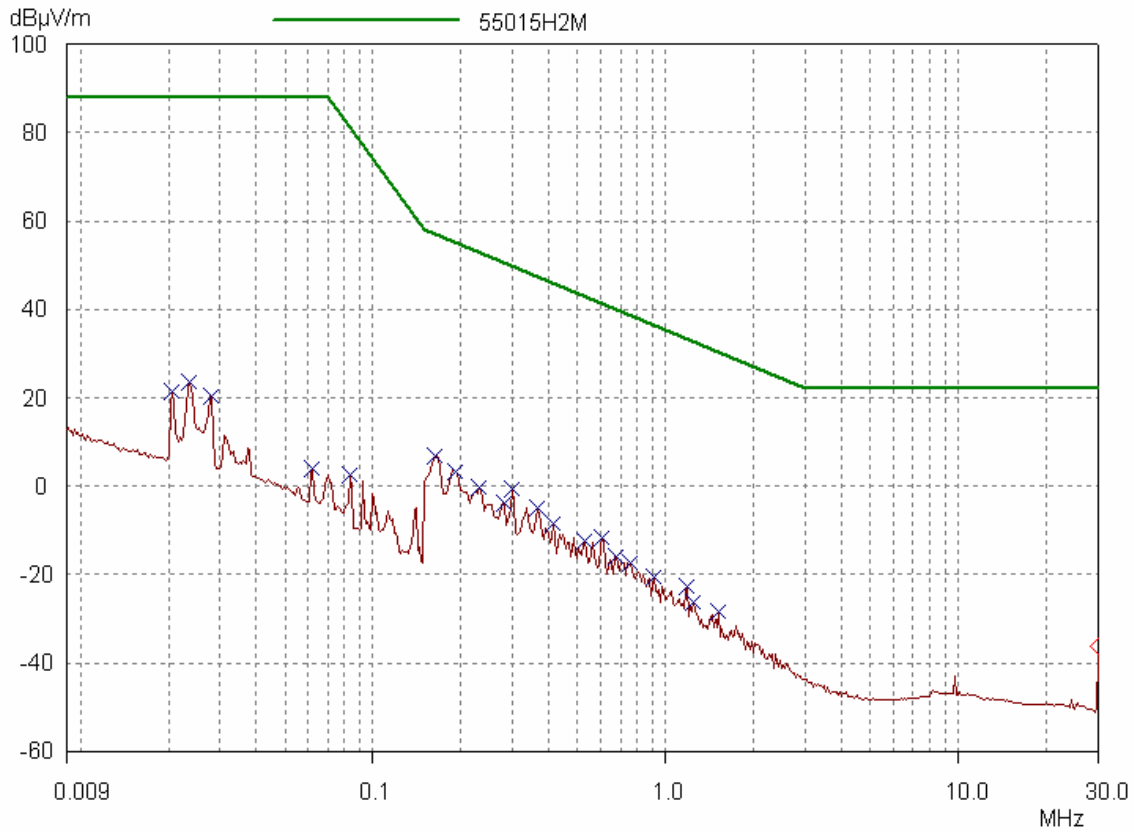

Frequency MHz	Level dBuV/m	Limit dBuV/m	Margin dBuV/m
0.0235	23.46	88.00	64.54
0.0206	21.45	88.00	66.55
0.0279	20.31	88.00	67.69
0.1635	6.99	56.96	49.97
0.0616	3.88	88.00	84.12
0.1905	3.32	55.13	51.81
0.0837	2.57	80.96	78.39
0.231	-0.31	52.81	53.12
0.2985	-0.66	49.73	50.39
0.2805	-3.98	50.48	54.46
0.366	-4.84	47.28	52.12
0.411	-8.56	45.89	54.45
0.6	-11.63	41.34	52.97
0.528	-12.29	42.88	55.17
0.6675	-15.78	40.06	55.84
0.7485	-17.37	38.68	56.05
0.897	-20.59	36.51	57.10
1.167	-22.60	33.35	55.95
1.23	-26.12	32.71	58.83
1.4955	-28.50	30.37	58.87

Plot 2e Q116RM1Z

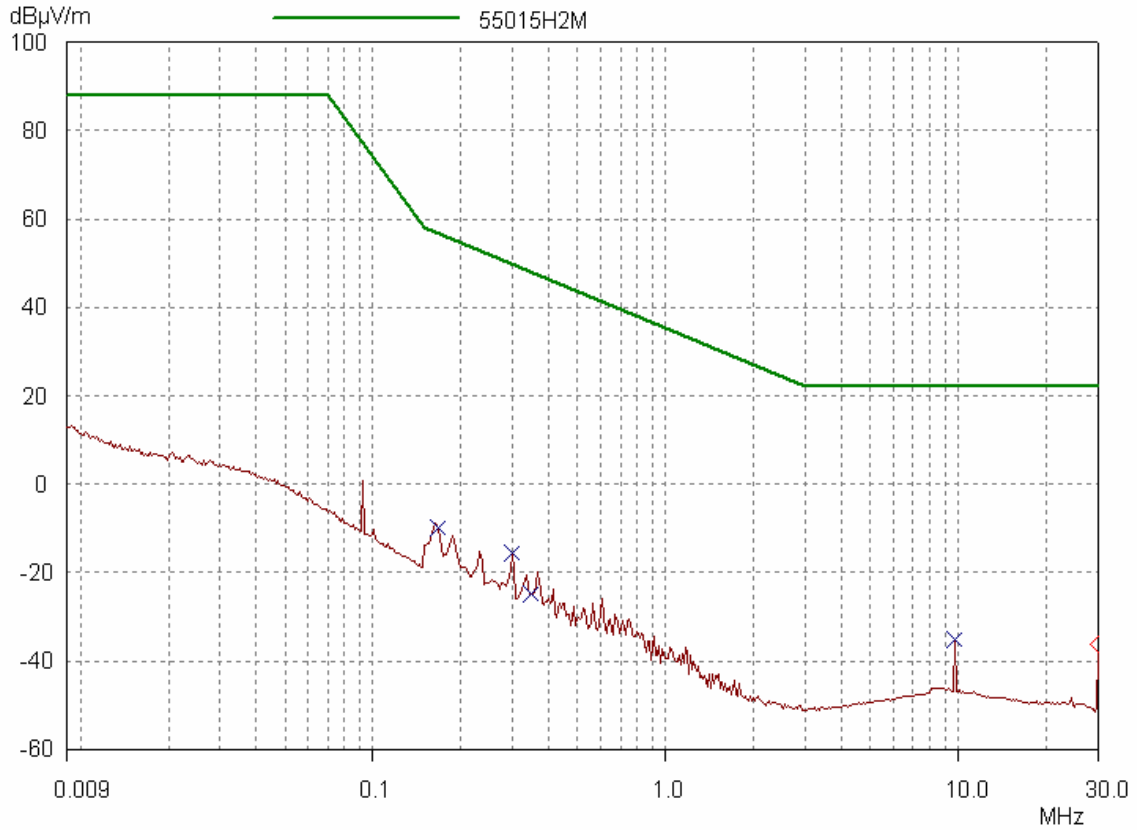

Frequency MHz	Level dBuV/m	Limit dBuV/m	Margin dBuV/m
0.168	-9.87	56.64	66.51
0.2985	-15.44	49.73	65.17
0.348	-24.78	47.89	72.67
9.5955	-35.11	22.00	57.11

8.3 Harmonic Current Emissions Results - Test File 282

Harmonics – Class-C per Ed. 3.0 (2006)(Run time)

EUT: ME Lighting (UK) Ltd - 49w 6ft

Tested by: TK

Test category: Class-C per Ed. 3.0 (2006) (European limits)

Test Margin: 100

Test date: 04/07/2011

Start time: 13:22:23

End time: 14:22:46

Test duration (min): 60

Data file name: H-000282.cts_data

Comment: Active

Customer: ME Lighting (UK) Ltd

Test Result: Pass

Source qualification: Normal

Current & voltage waveforms

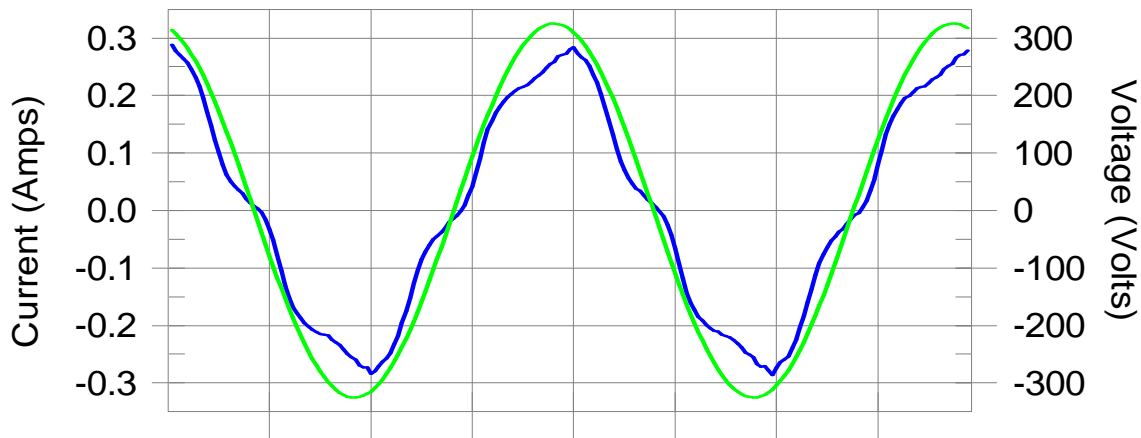

Harmonics and Class C limit line

European Limits

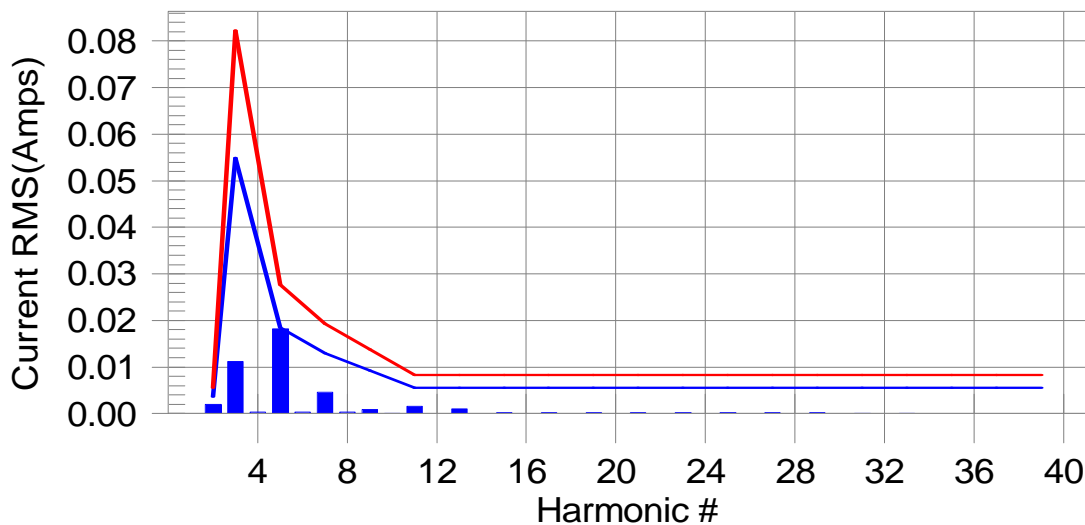

Test result: Pass Worst harmonics H5-99.76% of 100% limit, H5-67.51% of 150% limit.

Current Test Result Summary (Run time)

EUT: ME Lighting (UK) Ltd - 49w 6ft
 Test category: Class-C per Ed. 3.0 (2006) (European limits)
 Test date: 04/07/2011 Start time: 13:22:23
 Test duration (min): 60 Data file name: H-000282.cts_data
 Comment: Active
 Customer: ME Lighting (UK) Ltd

Tested by: TK
 Test Margin: 100
 End time: 14:22:46

Test Result: Pass Source qualification: Normal
 THC(A): 0.02 I-THD(%): 11.79 POHC(A): 0.000 POHC Limit(A): 0.017
 Highest parameter values during test:

V_RMS (Volts):	230.20	Frequency(Hz):	50.00
I_Peak (Amps):	0.292	I_RMS (Amps):	0.186
I_Fund (Amps):	0.184	Crest Factor:	1.579
Power (Watts):	42.4	Power Factor:	0.993

Harm#	Harms(avg)	100%Limit	%of Limit	Harms(max)	150%Limit	%of Limit	Status
2	0.002	0.004	0.0	0.002	0.006	0.00	Pass
3	0.011	0.055	20.5	0.012	0.082	14.20	Pass
4	0.001						
5	0.018	0.018	99.8	0.019	0.028	67.51	Pass
6	0.001						
7	0.005	0.013	36.8	0.005	0.019	26.99	Pass
8	0.000						
9	0.001	0.009	0.0	0.001	0.014	0.00	Pass
10	0.000						
11	0.002	0.006	0.0	0.002	0.008	0.00	Pass
12	0.000						
13	0.001	0.006	0.0	0.002	0.008	0.00	Pass
14	0.000						
15	0.000	0.006	0.0	0.000	0.008	0.00	Pass
16	0.000						
17	0.000	0.006	0.0	0.000	0.008	0.00	Pass
18	0.000						
19	0.000	0.006	0.0	0.000	0.008	0.00	Pass
20	0.000						
21	0.000	0.006	0.0	0.001	0.008	0.00	Pass
22	0.000						
23	0.000	0.006	0.0	0.001	0.008	0.00	Pass
24	0.000						
25	0.000	0.006	0.0	0.000	0.008	0.00	Pass
26	0.000						
27	0.000	0.006	0.0	0.000	0.008	0.00	Pass
28	0.000						
29	0.000	0.006	0.0	0.000	0.008	0.00	Pass
30	0.000						
31	0.000	0.006	0.0	0.000	0.008	0.00	Pass
32	0.000						
33	0.000	0.006	0.0	0.000	0.008	0.00	Pass
34	0.000						
35	0.000	0.006	0.0	0.000	0.008	0.00	Pass
36	0.000						
37	0.000	0.006	0.0	0.000	0.008	0.00	Pass
38	0.000						
39	0.000	0.006	0.0	0.000	0.008	0.00	Pass
40	0.000						

Note: Dynamic limits were applied for this test. The highest harmonics values in the above table may not occur at the same window as the maximum harmonics/limit ratio.

Voltage Source Verification Data (Run time)

EUT: ME Lighting (UK) Ltd - 49w 6ft
 Test category: Class-C per Ed. 3.0 (2006) (European limits)
 Test date: 04/07/2011 Start time: 13:22:23 End time: 14:22:46
 Test duration (min): 60 Data file name: H-000282.cts_data
 Comment: Active
 Customer: ME Lighting (UK) Ltd

Tested by: TK

Test Margin: 100

End time: 14:22:46

Start time: 13:22:23

Data file name: H-000282.cts_data

Test Result: Pass Source qualification: Normal

Highest parameter values during test:

Voltage (Vrms): 230.20 Frequency(Hz): 50.00
 I_Peak (Amps): 0.292 I_RMS (Amps): 0.186
 I_Fund (Amps): 0.184 Crest Factor: 1.579
 Power (Watts): 42.4 Power Factor: 0.993

Harm#	Harmonics V-rms	Limit V-rms	% of Limit	Status
2	0.137	0.460	29.81	OK
3	0.532	2.071	25.71	OK
4	0.037	0.460	8.10	OK
5	0.042	0.921	4.58	OK
6	0.020	0.460	4.30	OK
7	0.050	0.690	7.31	OK
8	0.019	0.460	4.09	OK
9	0.031	0.460	6.67	OK
10	0.015	0.460	3.23	OK
11	0.048	0.230	20.66	OK
12	0.011	0.230	4.62	OK
13	0.034	0.230	14.80	OK
14	0.011	0.230	4.61	OK
15	0.020	0.230	8.66	OK
16	0.016	0.230	6.93	OK
17	0.025	0.230	10.89	OK
18	0.015	0.230	6.40	OK
19	0.023	0.230	9.91	OK
20	0.017	0.230	7.56	OK
21	0.027	0.230	11.69	OK
22	0.007	0.230	3.14	OK
23	0.025	0.230	10.84	OK
24	0.005	0.230	1.96	OK
25	0.019	0.230	8.15	OK
26	0.007	0.230	3.24	OK
27	0.021	0.230	9.12	OK
28	0.005	0.230	2.28	OK
29	0.023	0.230	10.08	OK
30	0.005	0.230	2.07	OK
31	0.017	0.230	7.44	OK
32	0.007	0.230	2.88	OK
33	0.017	0.230	7.30	OK
34	0.003	0.230	1.18	OK
35	0.012	0.230	5.22	OK
36	0.003	0.230	1.50	OK
37	0.009	0.230	3.74	OK
38	0.003	0.230	1.18	OK
39	0.007	0.230	3.20	OK
40	0.011	0.230	4.73	OK

8.4 Voltage Fluctuation and Flicker Results - Test File 281

Flicker Test Summary per EN/IEC61000-3-3 (Run time)

EUT: ME Lighting (UK) Ltd - 49w 6ft
 Test category: All parameters (European limits)
 Test date: 04/07/2011 Start time: 11:14:24 End time: 13:19:45
 Test duration (min): 125 Data file name: F-000281.cts_data
 Comment: Active
 Customer: ME Lighting (UK) Ltd

Tested by: TK
 Test Margin: 100

Test Result: Pass

Status: Test Completed

Pst_i and limit line

European Limits

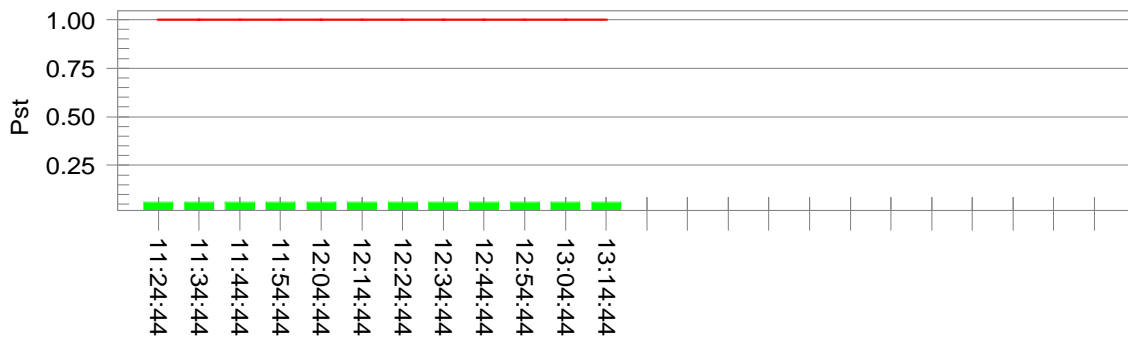

Plt and limit line



Parameter values recorded during the test:

Vrms at the end of test (Volt):	230.07			
Highest dt (%):	0.00	Test limit (%):	3.30	Pass
Time(mS) > dt:	0.0	Test limit (mS):	500.0	Pass
Highest dc (%):	0.00	Test limit (%):	3.30	Pass
Highest dmax (%):	0.00	Test limit (%):	4.00	Pass
Highest Pst (10 min. period):	0.064	Test limit:	1.000	Pass
Highest Plt (2 hr. period):	0.064	Test limit:	0.650	Pass

8.5 Inrush Current Results - Test File 283

Flicker Test Summary per EN/IEC61000-3-3 (Run time)

EUT: ME Lighting (UK) Ltd - 49w 6ft	Tested by: TK
Test category: InRush Current Test	Test Margin: 100
Test date: 04/07/2011	Start time: 15:05:49
Test duration (min): 60	End time: 15:30:10
Comment: Active	Data file name: F-000283.cts_data
Customer: ME Lighting (UK) Ltd	

Test Result: Pass

Status: Test Completed

European Limits

Parameter values recorded during the test:

Vrms at the end of test (Volt):	230.07	
Highest dmax (%):	-0.14	Test limit (%): 4.00
InRush Current(Amps-rms):	0.570	Test limit: < 20A

From the results obtained, the ME-T5-49w system tested, was found to be compliant with the following test requirements:

Emissions Tests		Standard	Status
Emissions Standard for Lighting Equipment		EN55015:2006 + A1:2007	Complied
Conducted Emissions AC Port	*	EN55015:2006 + A1:2007	Complied with a minimum margin of -25.72 dBuV
Radiated Emissions (Magnetic Field)	*	EN55015:2006 + A1:2007	Complied with a minimum margin of - 49.97 dBuV
Radiated Emissions (Electric Field)	*	EN55022:2006 + A1:2007 Class B	Complied with a minimum margin of - 14.53 dBuV/m
Harmonic Current Emissions		EN61000-3-2:2006 + A2:2009	Complied (99.76 % of the limit)
Voltage Fluctuation & Flicker		EN61000-3-3:2008	Complied
Inrush Current		EN61000-3-3:2008	Complied (0.570 A)

The EUT achieved compliance as per case A, where the measured results are below the specified limit by a margin greater than the measurement uncertainty (see Appendix Section).

* UKAS Accredited Tests

ELECTROMAGNETIC TESTING SERVICES LIMITED

EUT: T5 CONVERSION KIT, ME-T5-49W

COMPANY: ME LIGHTING (UK) LIMITED

TITLE OF SECTION: **EUT PERFORMANCE ASSESSMENT**

TEST REPORT NO: ETS/Q1657/EN

PAGE: 35 OF 73

ISSUE DATE: 08 AUGUST 2011

SECTION: 10.0

EUT Performance Assessment

During the application of the tests, the EUT's performance was assessed as per the customer's instructions as follows:

Observing the correct functionality and status of the EUT

12.1 ESD Results

TEST STANDARD : EN61547:1996 + A1:2000
 TEST SPECIFICATION : EN 61000-4-2:1995 + A1 + A2, ETS tpESD
 AIR/CONTACT DISCHARGE : Air discharge

Air Discharge - Compliance Criteria - B								
Test Point	Test Voltage Severity Level (kV)						P/F	Result
	- 2	- 4	- 8	+ 2	+ 4	+ 8		
	1	2	3	1	2	3		
Case All Sides	A	A	A	A	A	A	P	A
Adaptor Ends	A	A	A	A	A	A	P	A

Overall Result	A
Discussion	Achieved compliance with no degradation in performance

Temp	26 ° C - 26 ° C	Humidity	28 % RH - 27 % RH	Pa	1012 mbar - 1012 mbar	Date	01/07/2011
required	15° to 35° C	required	30% to 60% RH	required	860 to 1060 mbar	Tested by:	TK

A – No degradation in performance or loss of function during and after the test.
 B – Allowable degradation in performance during the test. Recovers after the test. No change in operating state or stored data allowed.
 C – Temporary Loss of Function during the test. Self Recoverable or can be restored by the operation of controls.
 NT - Not Tested
 ND - No Discharge
 F – EUT malfunctions and fails to recover.

12.1 ESD Results

TEST STANDARD : EN61547:1996 + A1:2000
 TEST SPECIFICATION : EN 61000-4-2:1995 + A1 + A2, ETS tpESD
 AIR/CONTACT DISCHARGE : Contact discharge

Contact Discharge - Compliance Criteria - B								
Test Point	Test Voltage Severity Level (kV)						P/F	Result
	- 2	- 4	- 6	+ 2	+ 4	+ 6		
	1	2	3	1	2	3		
Case All Sides	A	A	A	A	A	A	P	A
Indirect via HCP								
Bottom of Fitting	A	A	A	A	A	A	P	A
Front of Fitting	A	A	A	A	A	A	P	A
Rear of Fitting	A	A	A	A	A	A	P	A

Overall Result	A
Discussion	Achieved compliance with no degradation in performance

Temp	26 ° C - 26 ° C	Humidity	28 % RH - 27 % RH	Pa	1012 mbar - 1012 mbar	Date	01/07/2011
required	15° to 35° C	required	30% to 60% RH	required	860 to 1060 mbar	Tested by:	TK

A – No degradation in performance or loss of function during and after the test.
 B – Allowable degradation in performance during the test. Recovers after the test. No change in operating state or stored data allowed.
 C – Temporary Loss of Function during the test. Self Recoverable or can be restored by the operation of controls.
 NT - Not Tested
 ND - No Discharge
 F – EUT malfunctions and fails to recover.

12.2 Radiated Immunity Results

TEST STANDARD : EN61547:1996 + A1:2000

TEST SPECIFICATION : EN61000-4-3:1996

PERFORMANCE CRITERION : A

TEST SITE : Anechoic Chamber 1 / G-TEM

System/Sub assemblies	Enclosure & cables
Limit	3.0 V/m
Modulation	80% 1 kHz AM
Dwell Time	3 s
Step Size	1% log of momentary frequency

Vertical Polarisation					
Frequency	Orientation	Level (V/m)	File Name	P/F	Result
80 MHz - 1 GHz	Top	3	Q116RV01	P	A
80 MHz - 1 GHz	Front	3	Q116RV02	P	A
80 MHz - 1 GHz	Side	3	Q116RV03	P	A

Horizontal Polarisation					
Frequency	Orientation	Level (V/m)	File Name	P/F	Result
80 MHz - 1 GHz	Top	3	Q116RH01	P	A
80 MHz - 1 GHz	Front	3	Q116RH02	P	A
80 MHz - 1 GHz	Side	3	Q116RH03	P	A

EUT Temp:	24 °C	%RH	44 %	Pa:	998 mB	Tested by:	GV / TK	Date:	21/06/2011
------------------	-------	------------	------	------------	--------	-------------------	---------	--------------	------------

Overall Result	A
Discussion	Achieved compliance with no degradation in performance

A – No degradation in performance or loss of function during and after the test.
 B – Allowable degradation in performance during the test. Recovers after the test. No change in operating state or stored data allowed.
 C – Temporary Loss of Function during the test. Self Recoverable or can be restored by the operation of controls.

12.3 Fast Transient Results - AC Mains Power Cable

TEST STANDARD : EN61547:1996 + A1:2000
 TEST SPECIFICATION : EN61000-4-4:1995, ETS tpFTB modula
 PERFORMANCE CRITERION : B
 COUPLING MODE : Direct

Port Under Test		AC Power					MIN Test
Application Frequency		5kHz					
Pulse		75					
Repetition Rate		300 ms					
Test Duration		1 min					
Direct Coupling				Result		Overall Result	Results File
AC	Level	Test File	Voltage (kV)	+ ve	- ve		
L-N-PE	2 (1kV)	pwr1kmin	0.5	A	A	Passed	Q116FT00
			0.75	A	A		
			1.0	A	A		

Overall Result	A
Discussion	Achieved compliance with no degradation in performance

EUT Temp:	20 °C	%RH	54 %	Pa:	1009 mB	Tested by:	TK	Date:	24/06/2011
------------------	-------	------------	------	------------	---------	-------------------	----	--------------	------------

A – No degradation in performance or loss of function during and after the test.
 B – Allowable degradation in performance during the test. Recovers after the test. No change in operating state or stored data allowed.
 C – Temporary Loss of Function during the test. Self Recoverable or can be restored by the operation of controls.
 F – EUT malfunctions and fails to recover.

12.4 Surge Immunity Results

TEST STANDARD : EN61547:1996 + A1:2000
 TEST SPECIFICATION : EN61000-4-5:1995 + A1 + A2, ETS tpSURGE modula
 PERFORMANCE CRITERION : B

Port Type	AC Mains										No of Surges 5		Pulse interval 20s			
Mode	Differential Mode				Common Mode											
Test Type	Live to Neutral				Live to Earth						Neutral to Earth					
Phase Angle	+0.5	+1.0	-0.5	-1.0	+0.5	+1.0	+2.0	-0.5	-1.0	-2.0	+0.5	+1.0	+2.0	-0.5	-1.0	-2.0
Mains Supply Angle °																
0	A	A	A	A	A	A	A	A	A	A	A	A	A	A	A	A
90	A	A	A	A	A	A	A	A	A	A	A	A	A	A	A	A
180	A	A	A	A	A	A	A	A	A	A	A	A	A	A	A	A
270	A	A	A	A	A	A	A	A	A	A	A	A	A	A	A	A
Test File	SLN1KP2		SLN1KN2		SLE1KP2		SLE2KP2	SLE1KN2		SLE2KN2	SNE1KP2		SNE2KP2	SNE1KN2		SN E2KN2
Results Filename	Q116SR01															
Test Filename	AC2K20s / AC2K60s															

Overall Result	A
Discussion	Achieved compliance with no degradation in performance

EUT Temp:	20 °C	%RH	54 %	Pa:	1009 mB	Tested by:	GV / TK	Date:	24/06/2011
------------------	-------	------------	------	------------	---------	-------------------	---------	--------------	------------

A – No degradation in performance or loss of function during and after the test.
 B – Allowable degradation in performance during the test. Recovers after the test. No change in operating state or stored data allowed.
 C – Temporary Loss of Function during the test. Self Recoverable or can be restored by the operation of controls.
 F – EUT malfunctions and fails to recover.

12.5 Conducted Immunity Results

TEST STANDARD : EN61547:1996 + A1:2000

TEST SPECIFICATION : EN61000-4-6:2007

PERFORMANCE CRITERION : A

Frequency Range:	150 kHz - 80 MHz
Amplitude Modulation:	80% AM @ 1 kHz sinusoidal
Level 3:	3 Vrms
Sweep Rate:	1.0% log of momentary frequency
Dwell Time:	3 s
Performance Criterion	A

Port Type	CDN	Level (Vrms)	File Name	P / F	Result
Mains Power port	Luthi M3	3	Q116CA01	P	A

Overall Result	A
Discussion	Achieved compliance with no degradation in performance

EUT Temp:	20 °C	%RH	54 %	Pa:	1009 mB	Tested by:	TK	Date:	24/06/2011
------------------	-------	------------	------	------------	---------	-------------------	----	--------------	------------

A – No degradation in performance or loss of function during and after the test.

B – Allowable degradation in performance during the test. Recovers after the test. No change in operating state or stored data allowed.

C – Temporary Loss of Function during the test. Self Recoverable or can be restored by the operation of controls.

F – EUT malfunctions and fails to recover.

12.6 Magnetic Field Results

TEST STANDARD : EN61547:1996 + A1:2000
 TEST SPECIFICATION : EN61000-4-8:1993, ETS tpPwrFreqMag Modula
 PERFORMANCE CRITERION : A

Test Set Up	
Frequency	50 Hz
Magnetic Field	3 A/m

Orientation	Test File	File	P/F	Result
X Plane (Horizontal)	MGM1TB	Use file Q116mg01	A	A
Y Plane (Vertical)			A	A
Z Plane			A	A

Overall Result	A
Discussion	Achieved compliance with no degradation in performance

EUT Temp:	20 °C	%RH	54 %	Pa:	1009 mB	Tested by:	TK	Date:	24/06/2011
------------------	-------	------------	------	------------	---------	-------------------	----	--------------	------------

A – No degradation in performance or loss of function during and after the test.
 B – Allowable degradation in performance during the test. Recovers after the test. No change in operating state or stored data allowed.
 C – Temporary Loss of Function during the test. Self Recoverable or can be restored by the operation of controls.
 F – EUT malfunctions and fails to recover.

12.7 Voltage Dips / Interruptions Results

TEST STANDARD : EN61547:1996 + A1:2000
 TEST SPECIFICATION : EN61000-4-11:1994, ETS tpDips&Int

Port Type	% Dip	Duration (Seconds)	Repetition Rate (Seconds)	Test Time (mins)	Per. Crit.	File Name	P/F	Result
Mains Power	100	0.01	30	5	B	Q116VD01	P	A
	30	0.2	30	5	C		P	A

Overall Result	A
Discussion	Achieved compliance with no degradation in performance

EUT Temp:	20 °C	%RH	54 %	Pa:	1009 mB	Tested by:	TK	Date:	24/06/2011
------------------	-------	------------	------	------------	---------	-------------------	----	--------------	------------

A – No degradation in performance or loss of function during and after the test.
 B – Allowable degradation in performance during the test. Recovers after the test. No change in operating state or stored data allowed.
 C – Temporary Loss of Function during the test. Self Recoverable or can be restored by the operation of controls.
 F – EUT malfunctions and fails to recover.

From the results obtained, the ME-T5-49w system tested, was found to be compliant with the following tests of the EN61547:1996 +A1:2000 Immunity Standard.

Immunity Tests		Standard	Status
Immunity standard for Lighting Equipment		EN61547:1996 +A1:2000	Complied
Electrostatic Discharge	*	EN61000-4-2:1995	Complied
Radiated Immunity		EN61000-4-3:2006	Complied
Fast Transient Bursts	*	EN61000-4-4:1995	Complied
Surges	*	EN61000-4-5:1995	Complied
Conducted Immunity		EN61000-4-6:2007	Complied
Magnetic Field Immunity	*	EN61000-4-8:1993	Complied
Voltage Dips	*	EN61000-4-11:1994	Complied
Voltage Interruptions	*	EN61000-4-11:1994	Complied

* UKAS Accredited Tests

Appendix A	Photographs of Test Set-Up
Appendix B	Immunity Test Results RF Radiated Field Immunity Graphs RF Conducted Field Immunity Graphs
Appendix C	Measurement Uncertainty
Appendix D	List of Equipment Used
Appendix E	Support Equipment
Appendix F	Modification Record
Appendix G	Emissions - Test Procedures / Set-Up Conducted Emissions Radiated Emissions Harmonic Current Emissions Voltage Fluctuation & Flicker
Appendix H	Immunity - Test Procedures / Set-Up Electrostatic Discharge (ESD) RF Radiated Field Immunity Fast Transients/Burst Immunity Surge Immunity Test Conducted Immunity Magnetic Field Immunity Voltage Dips/Interruptions
Appendix I	Abbreviations
Appendix J	EU Compliance and Labelling Requirements

Radiated Emissions



Conducted Emissions AC Port



Mains Harmonic, Flicker and Inrush Current



ESD



Radiated Immunity



Conducted Immunity

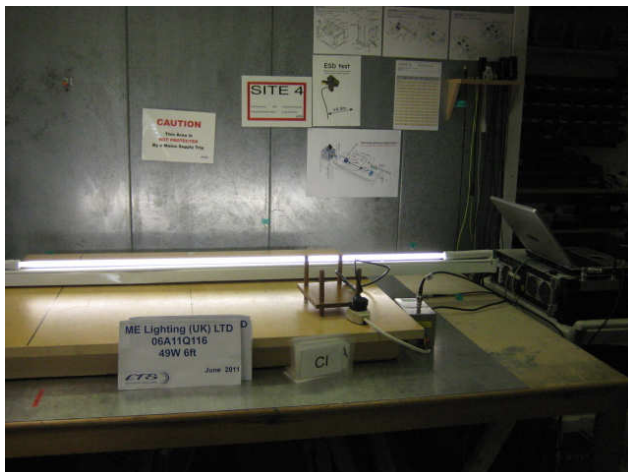

Fast Transients, Surges,



Voltage Dips / Interruptions, Magnetic Immunity



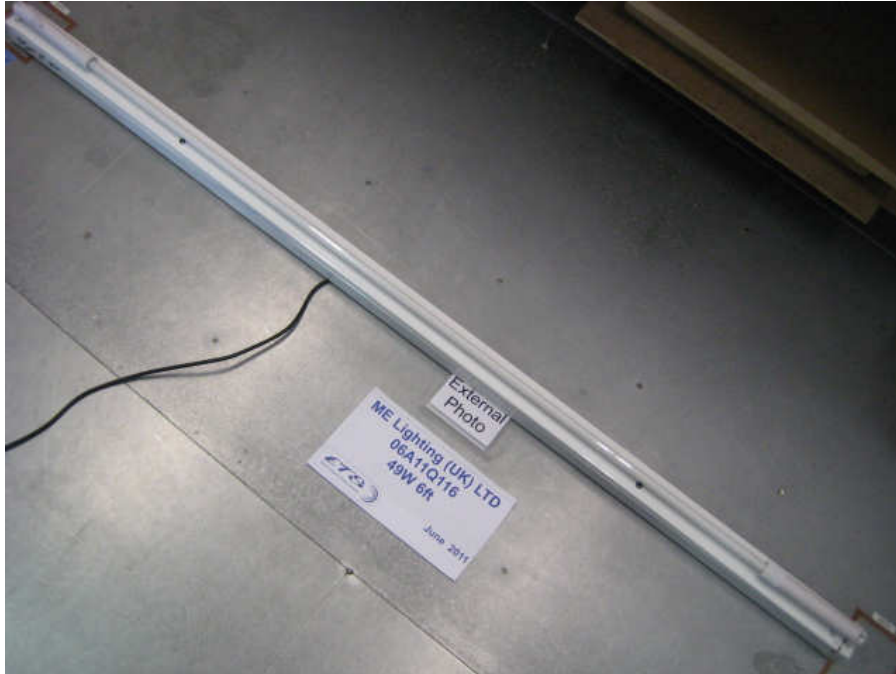

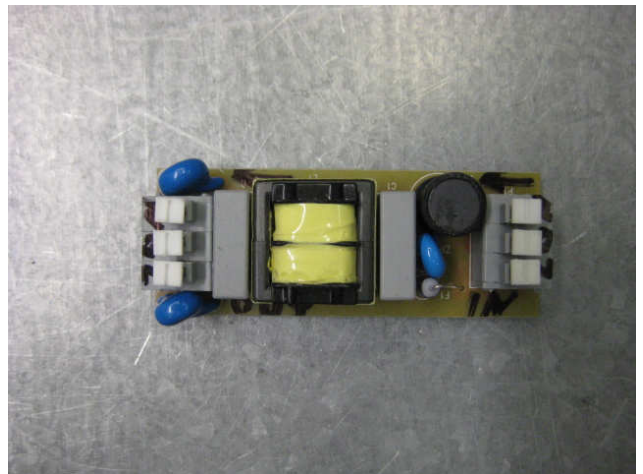
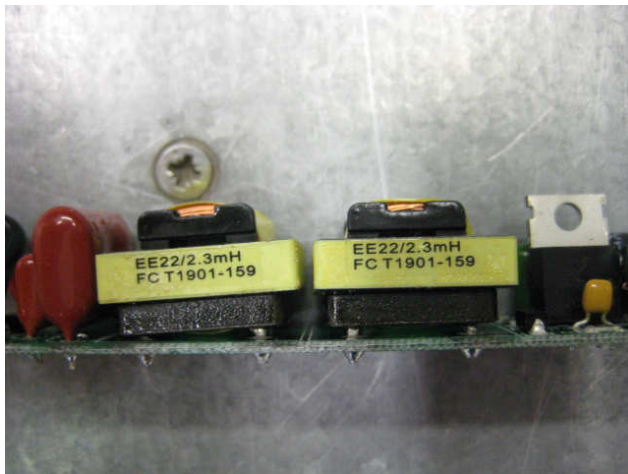

RF Radiated Field Immunity Graphs

Q116RV01

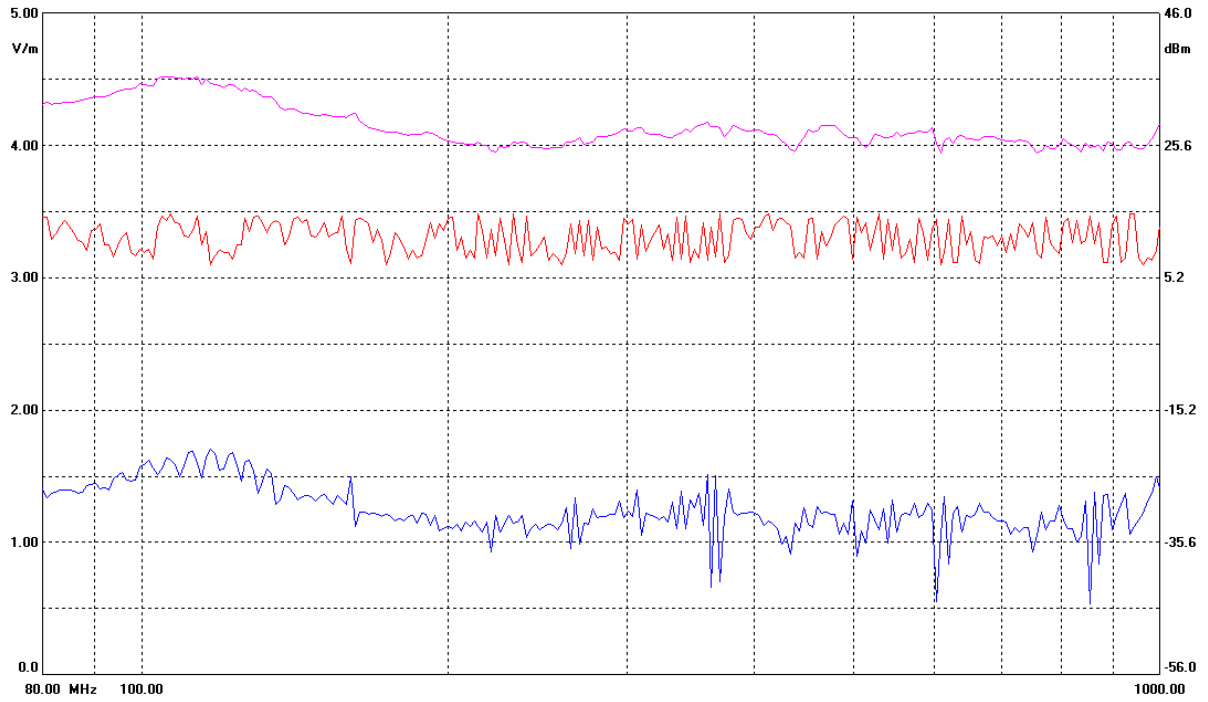

Q116RH01

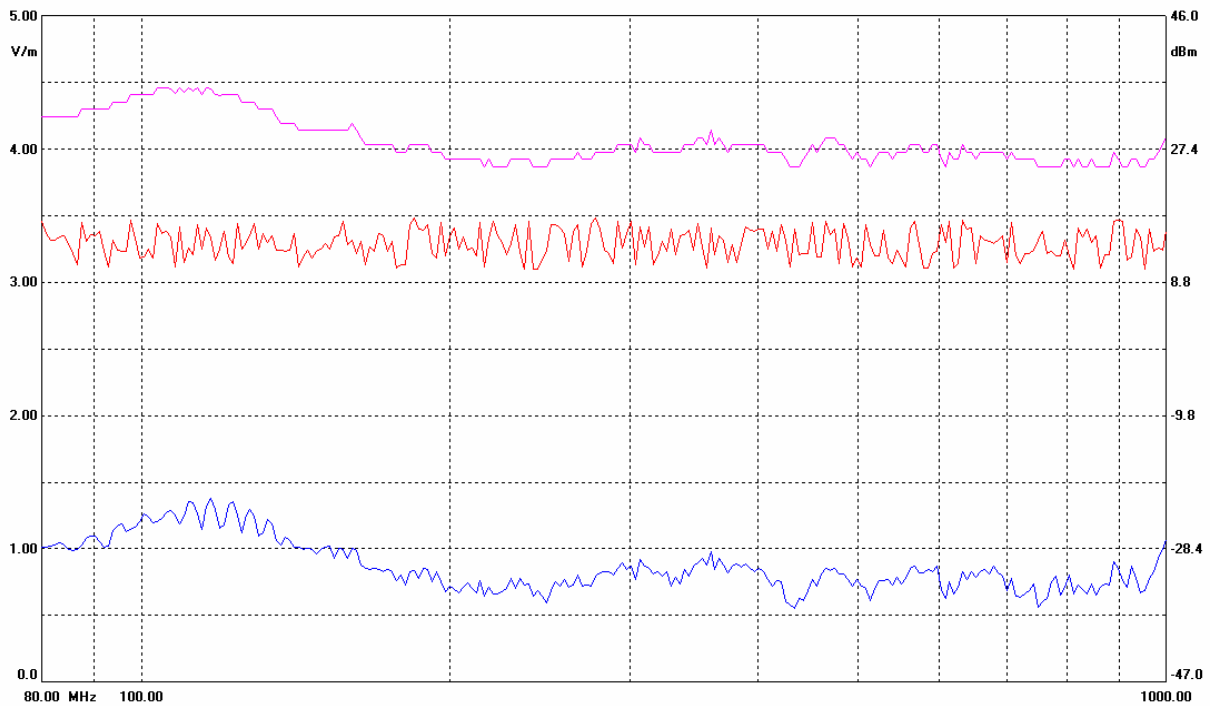

RF Radiated Field Immunity Graphs

Q116RV02

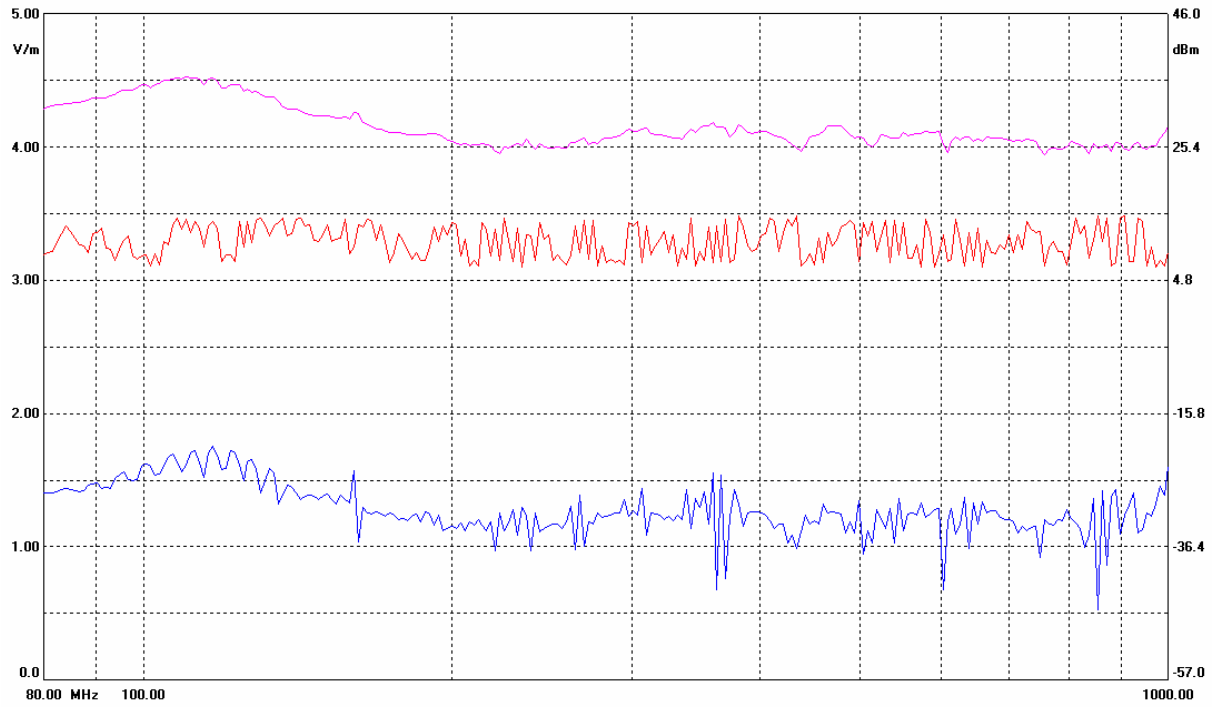

Q116RH02

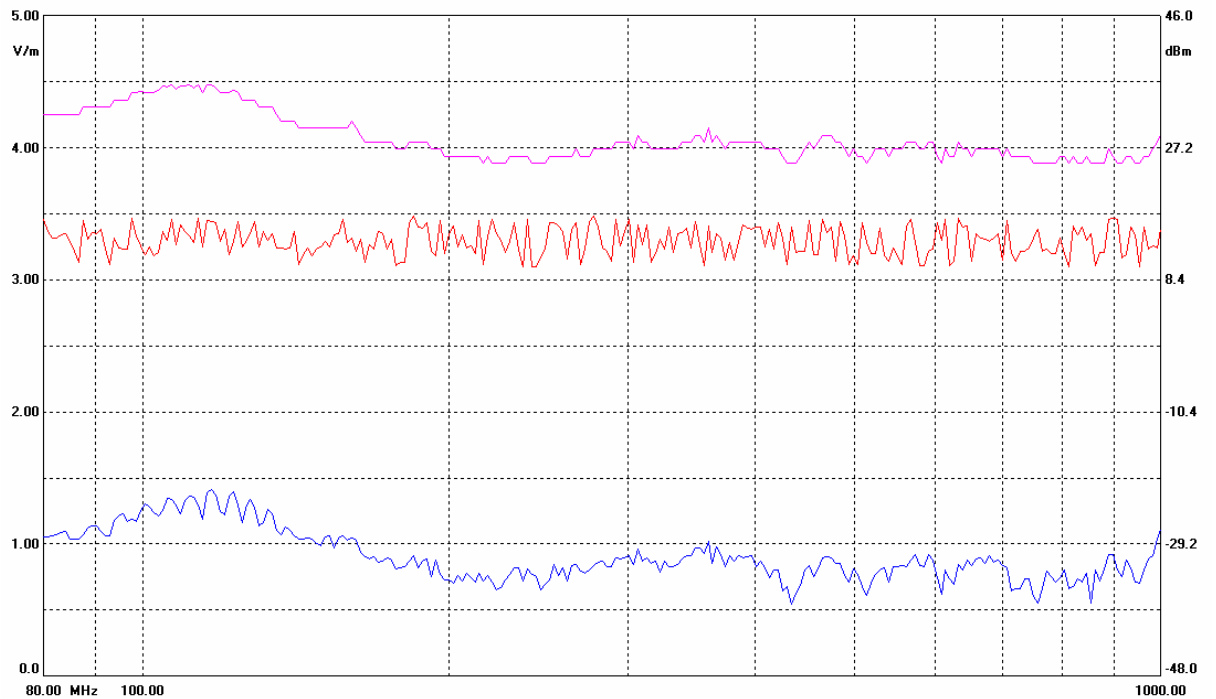

RF Radiated Field Immunity Graphs

Q116RV03

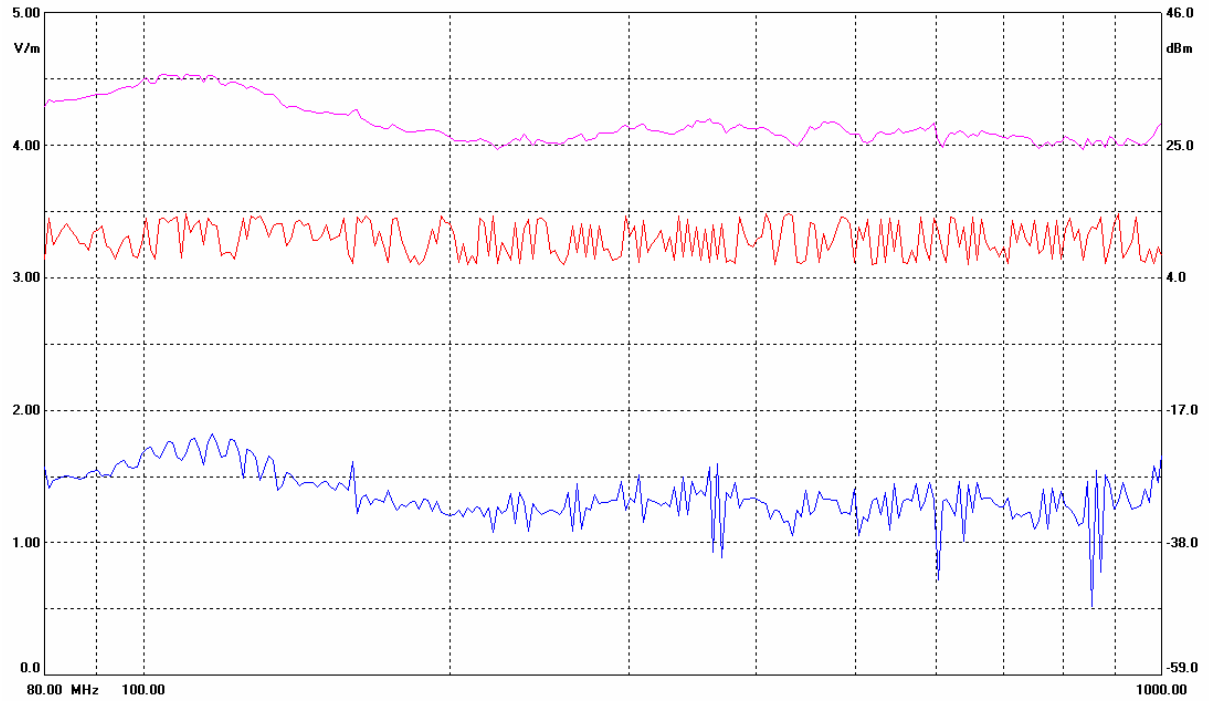

Q116RH03

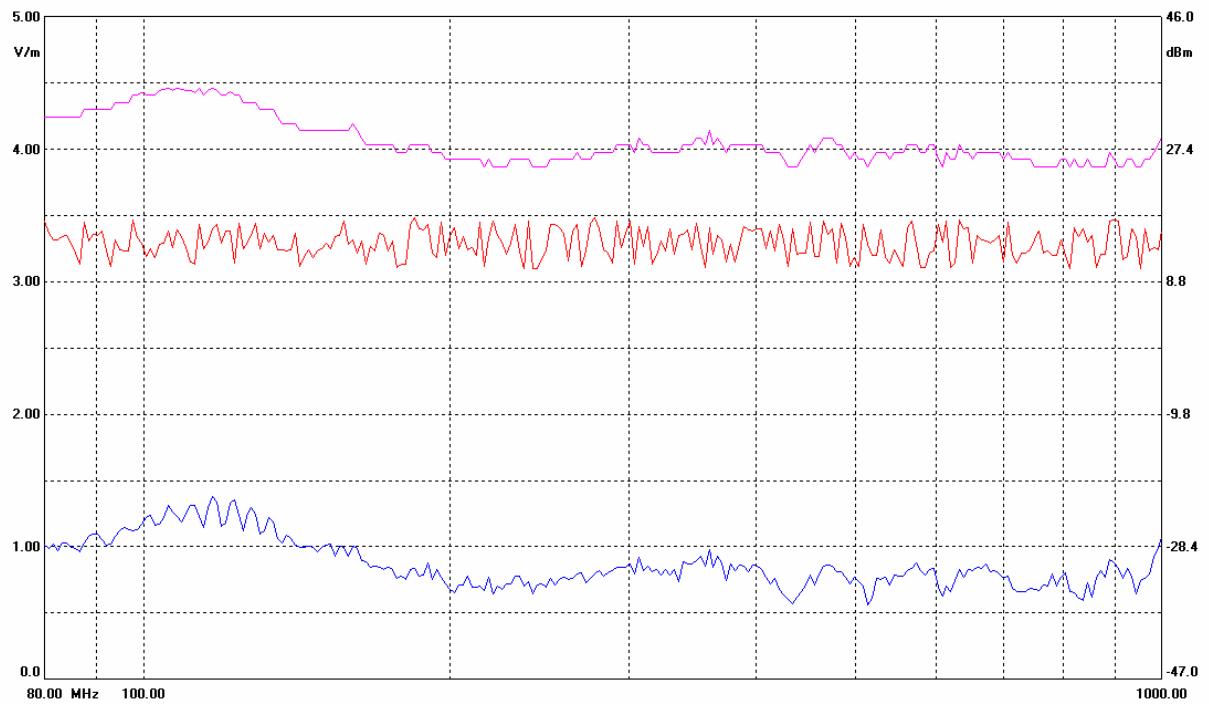

RF Conducted Field Immunity Graph

NSG 4070 Test Report

Date :25/06/2011 12:27:18
 EUT: MEL UK Ltd - 6ft 49w

Notes to EUT: Active
 Active

Standard : IEC 61000-4-6 (2006)

Modulation : AM 1000 Hz 80 % Dwell Time : 3.000 ms

Amplifier : internal Comment :

Test Title : 4-6 CDN / EM-CLAMP / CIP / IEC 61000-4-6 (2006) / NSG 4070-75 Nr: 000022 / V1.28

Connected line	Frequency range [MHz]	Test level (EMK)	Step size	Coupl. device	Result File
Mains input	0.15...80	3...3 V	1 %	CDN	Q117ca01.res

Ambient temperature : 24 DegC 41% 1001mB
 Humidity : 24 DegC 41% 1001mB
 Pressure : 24 DegC 41% 1001mB

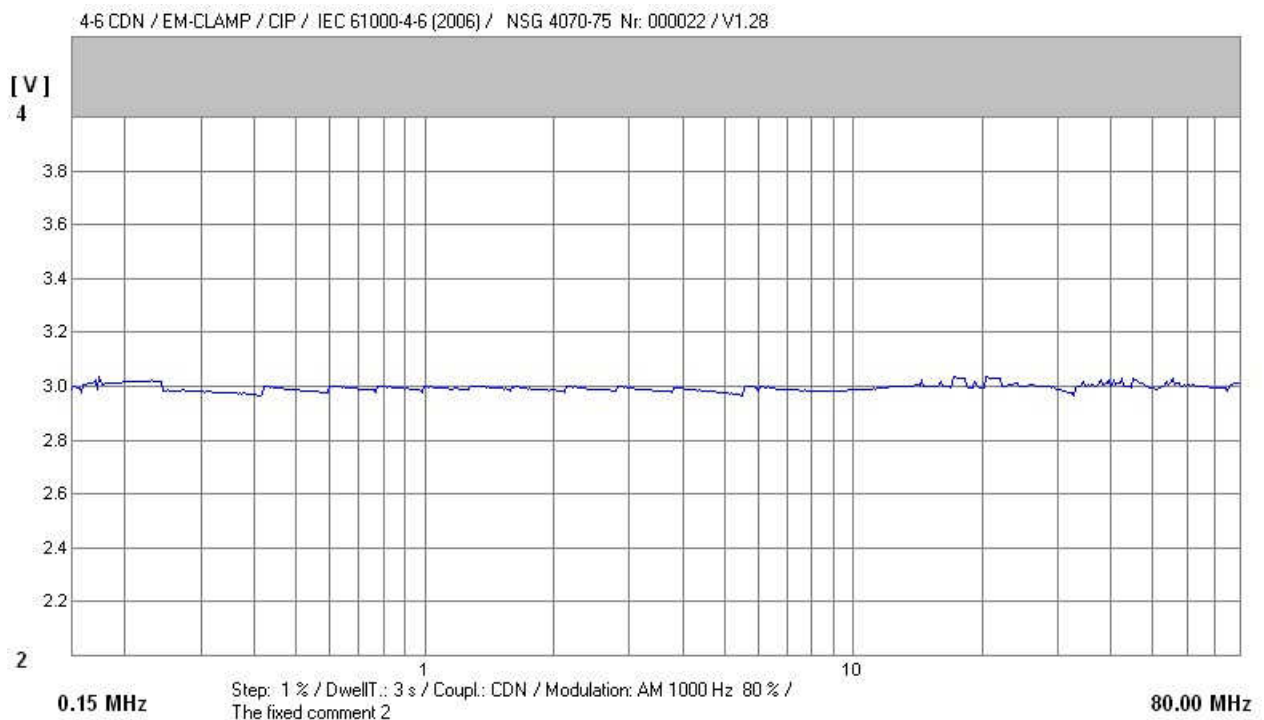

Measurement Uncertainty

The reported expanded measurement uncertainties are based on a standard uncertainty multiplied by a coverage factor of $k = 2$, providing a confidence level of approx. 95%. The uncertainty evaluation has been carried out in accordance with M3003 requirements.

The estimated combined standard measurement uncertainties are:

Conducted Emissions	9 KHz - 30 MHz	± 1.9 dB	Radiated Immunity	- 0 + 6 dB
Radiated Emissions	30 MHz - 300 MHz	± 2.7 dB	Conducted Immunity	± 1.51 dB
	300 MHz - 1 GHz	± 2.97 dB	Mains Harmonics	± 11.5 %
ESD	It has been demonstrated that the test generator meets the specified requirements in the standard with at least a 95% confidence.		Flicker	± 11.6 %
Fast Transients				
Surges				
Magnetic Immunity				
Voltage Dips / Interruptions				

Compliance Cases

Case A	Case B	Case C	Case D
<p>The product complies.</p>	<p>The measured result is below the specification limit by a margin less than half the uncertainty interval; it is not therefore possible to determine compliance at a level of confidence of 95%. However, the measurement result indicates a higher probability that the product complies.</p>	<p>The measured results is above the specification limit by a margin less than half the uncertainty interval; it is not therefore possible to determine compliance at a level of confidence of 95%. However, the measurement result indicates a higher probability that the product does not comply.</p>	<p>The product does not comply.</p>

Traceability

All measurement equipment calibrations are traceable to national standards.

Calibration

Equipment requiring calibration is calibrated to Manufacturer's specifications. Additional verification tests are performed on a regular basis using in house standards and comparisons.

**Test Equipment used**

TG Number	Description	Model Number	Manufacturer	Serial Number
Conducted RF Emissions				
2	Receiver (20Hz to 7GHz)	ESIB7	Rohde & Schwarz	100074
3a	Receiver (20 Hz to 40GHz) Click Test	ESU40	Rohde & Schwarz	100069
22	Line Impedance Stabilising Network (3 phase)	NNLK8121	Schwarzbeck	8121300
23	Line Impedance Stabilising Network	ESH3Z5	Rohde & Schwarz	848773/020
71	ISN (telecommunication ports)	ISN T800	Teseq	24566
158	Coaxial switch (2 way)	651-850	RS	N/A
157	Multi-way RF switch*	N/A	ETS	N/A
152	Screened Room	site 9	ETS	N/A
141	Laptop	PC014	HP	CND4110422
	Keyboard and Mouse			
Diagnostic Radiated RF Emissions				
1	Receiver (20MHz to 1GHz)*	ESV10	Rohde & Schwarz	843207/012
12	Bi-log antenna (25MHz to 1.3GHz)	ALPB-2513	ARA	1020
97	RE 10 dB Attenuator	RE 10 dB Pad	RS	none
159	Coaxial switch (2 way)	651-850	RS	N/A
157	Multi-way RF switch*	N/A	ETS	N/A
155	Semi-Anechoic Room	site 5	ETS	N/A
141	Laptop	PC014	HP	CND4110422
170	Emissions Software	N/A	Rohde & Schwarz	N/A
	Keyboard and Mouse			
Radiated RF Emissions (OATS)				
1	Receiver (20MHz to 1GHz)*	ESV10	Rohde & Schwarz	843207/012
9	Biconical antenna (20MHz to 300MHz)	HK116	Rohde & Schwarz	843562/010
10	Log-periodic antenna (200MHz to 1GHz)	HL223	Rohde & Schwarz	843990/012
151	Open Area Test Site	site 1	ETS	N/A
104	Positioning Controller (Antenna mast)	1090	EMCO	none
163	Antenna mast	1090	EMCO	0
162	Controller Turntable	N/A	ETS	0
164	Turntable	N/A	ETS	0
142	Laptop	PC015	Compaq	CNF338QB
171	Maximisation Software	N/A	ETS	N/A
	Keyboard and Mouse			
Harmonics and Flicker				
26	Harmonics and flicker analyser AC source and impedance link	Proflin 2105-400 NSG1007/CCN1000	Schaffner	35000777 / HK54006 / 71825



Test Equipment used

TG Number	Description	Model Number	Manufacturer	Serial Number
-----------	-------------	--------------	--------------	---------------

1) Voltage Dips and Interrupts. 2) Fast Transient Bursts. 3) Surge. 4) Magnetic				
54	Immunity test system	Schaffner Best EMC	Schaffner	200038-057SC
125	Master Controller	Modula 6050	Schaffner	34526
126	Magnetic Field Generator	MFO 6502	Schaffner	102
127	Double Motor-Variac	VAR6502-CIB	Schaffner	103
138	Patriot 2006 Laptop (modula)	PC011	Patriot	ETSG0807-04
175	Transient Immunity Software	Modula	Schaffner	N/A

Conducted RF Immunity				
70	RF Generator	NSG4070-75	Teseq	22
98	150 W 6 dB Attenuator	150-A-FFN-06	Bird	702
80	20 dB 75 W Attenuator	8308-200	BIRD	MFC70998
29	EM Injection Clamp 10 kHz - 1 GHz	Chase CIC9851	Chase EMC (TESEC)	17
30	Bulk Current Injection Probe 10 kHz - 400 MHz	FCC F-120-6A	FCC	70
43	CDN M3	CDN 801-M3 (IEA)	LUTHI	1504
44	CDN	MEB CDN 801-AF2-1	0	7301X
45	CDN M3	FCC-801-M3-25	FCC	75
46	T2	FCC-801-T2	FCC	1016
47	CDN M2	FCC-80-AF2	FCC	2001
48	AF2	A201-A	Schaffner	16464
49	A201	A201-B	Schaffner	16469
50	CDN M1	CDN-M1	MEB	13355
51	150 kHz - 230 MHz	CDN-M2-50	Schaffner	9987
52	0	0	0	0
53	XLR CABLE CDN	CDN S200	Schaffner	15876
174	Conducted RF Immunity Software	NSG 4070	Teseq	N/A

Radiated RF Immunity GTEM				
74	GTEM	GTEM 5311 (Site 08)	EMCO	9411-1124
165	Signal Generator 100kHz to 22GHz	SMF 100A	Rohde & Schwarz	100119
124	Power Amplifier 25-1000 MHz	30W1000M7	Amplifier Research	16877
122	Microwave Amplifier Series 2000	AS0104-55_55	Milmega	1028724
76	Dual Channel Power Meter	NRVD	Rohde & Schwarz	101991
77	Thermal Power Sensor	NRV-Z51	Rohde & Schwarz	101705
78	Thermal Power Sensor	NRV-Z51	Rohde & Schwarz	101704
120	Data Processing Interface Unit	7110	EMCO	9204-1180
133	Dimension LS00C Desktop	PC006	Dell	ETSG0807-01
172	Immunity Software	702	EMC Hire	N/A

ESD				
59	ESD Simulator	NSG435	Schaffner	1293
60	ESD Simulator	NSG438	Schaffner	749

Radiated RF Immunity SAR				
155	Semi-Anechoic Room	site 5	ETS	N/A
39	RF Signal Generator 9 kHz - 3.3 GHz	SML03	R&S	100901
37	RF Amp 80 MHz - 1 GHz 100W	CBA9413A	Schaffner	?
12	Bi-log antenna (25MHz to 1.3GHz)	ALPB-2513	ARA	1020
116	RF Power Meter	6960A	Marconi	2436

Conducted Emissions Measurements

Objectives

The objectives are to determine the level of conducted emissions at the Telecommunication ports in the frequency range 150 kHz to 30 MHz. Measured levels are evaluated against the applicable limits of the EN55015: 2006 standard and amendments A1:2007.
 Test Procedure ETS tpCE

Test Method

Conducted emissions measurements are made over the frequency range 150 kHz - 30 MHz in accordance with EN55015:2006 amendments A1:2007. Prior to the commencement of tests the test equipment, EUT and support equipment are switched on and allowed to warm up for a minimum of thirty minutes. The RF test receiver parameters are set as per the requirements of CISPR 16/ EN55022.
 The EUT is positioned on a non-conductive table 0.8 m above the ground plane.
 Recording of test results is by automated scans with the presentation of results in a graphical and tabulated form. References must also to be made to EN55015:2006 Section 9.

Test Set-up

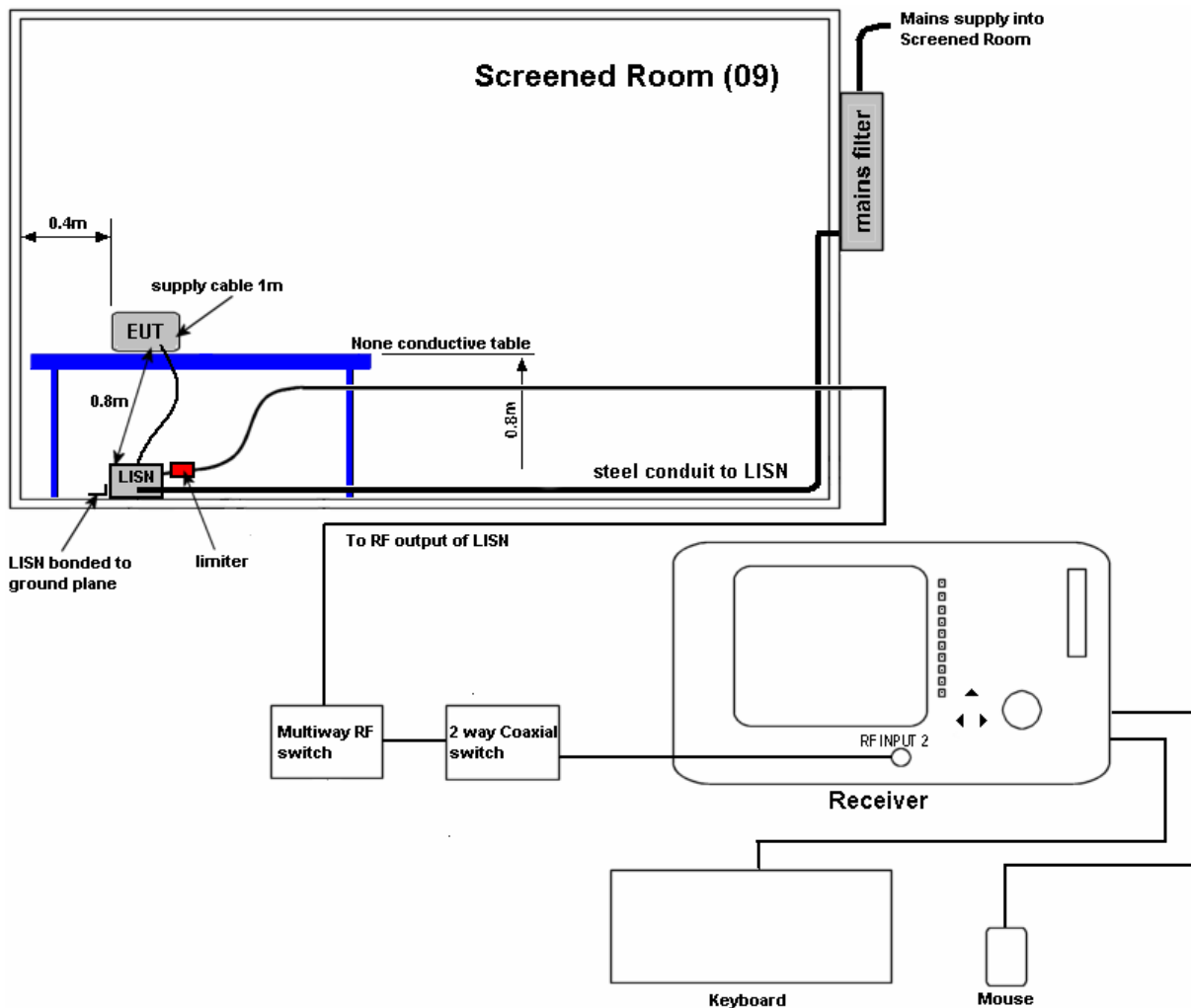

Harmonic Current Emissions Measurements

Objectives

To assess the Harmonic Emissions from the EUT against the applicable classification requirements of EN61000-3-2:2006.

Test Method

The EUT was connected to the Schaffner Harmonic test system which was controlled by a PC running Schaffner Win2100 Version 3.03 test software.

The voltage settings were 230 V 50 Hz. Test parameters and data were automatically monitored and collected by the test software. The test duration was 60 minutes during which time the EUT was exercised in its considered worst operating mode.

Test Set Up

The EUT was connected to the test system as shown on the diagram below.

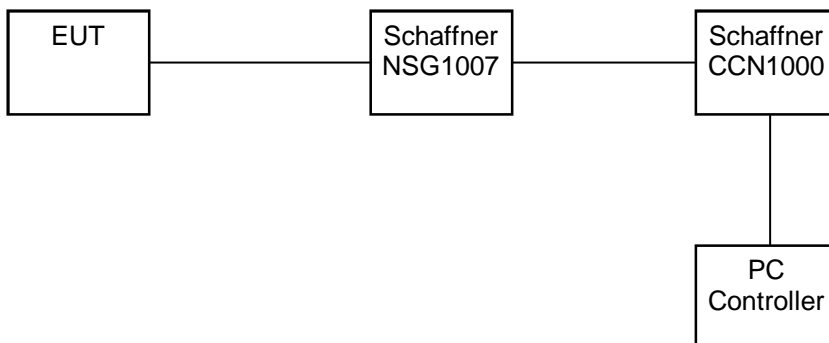

Voltage Fluctuation and Flicker Measurements

Objectives

To assess the voltage fluctuation and flicker caused by the EUT and impressed on the public Low Voltage System, against the applicable classification requirements of EN61000-3-3:2008.

Test Method

The EUT was connected to the Schaffner Harmonic test system which was controlled by a PC running Schaffner Win2100 Version 3.03 test software.

The voltage settings were 230 V 50 Hz. Test parameters and data were automatically monitored and collected by the test software. The test duration was 125 minutes during which time the EUT was exercised in its considered worst operating mode.

Test Set Up

The EUT was connected to the test system as shown on the diagram below.

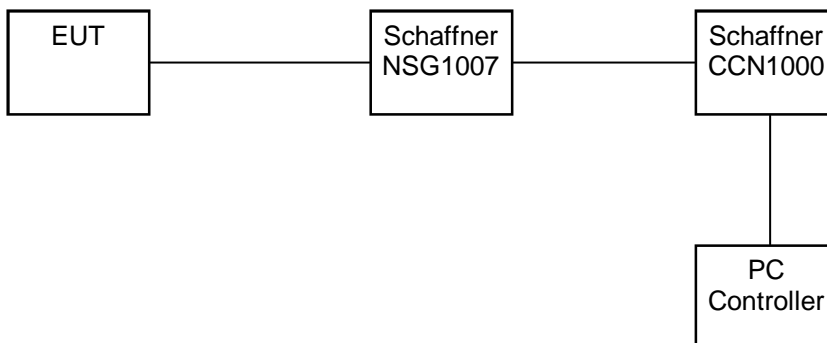

Electrostatic Discharge (ESD) Immunity

Objectives

To establish the performance of the equipment under test (EUT) when subjected to electrostatic discharges. Testing also includes electrostatic discharges that may occur indirectly from personnel to objects near vital equipment.

Test Procedure ETS tpESD

Test Method

Tests are carried out to the applicable level as per the Contact and Air Discharge requirements of EN61000-4-2:1995. Vertical and Horizontal coupling plan (VCP), (HCP) discharges are applied at selected locations around the EUT.

Prior to commencing the test, a functional test was performed on the EUT to ensure correct operation. During testing the EUT was monitored for any degradation in performance.

Test Set Up

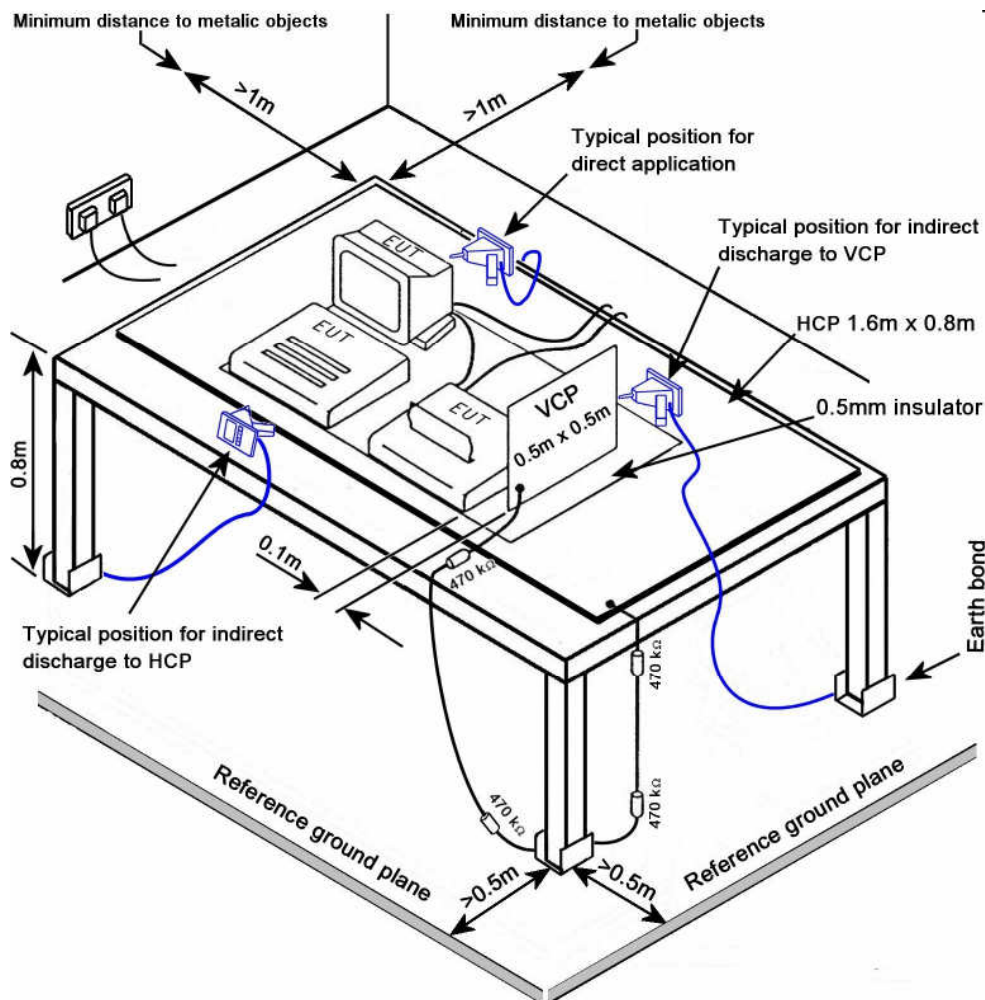

RF Radiated Field Immunity Test

Chamber

Objectives

To establish the performance of the equipment under test (EUT) when subjected to radio frequency electromagnetic fields.

Test Method

Tests were carried out in the Anechoic Chamber to the applicable levels, in the frequency range 80 MHz to 1 GHz. In accordance with the requirements of EN61000-4-3:1996.

The test field was 80% AM modulated with 1 kHz sine wave. The field frequency was swept under computer control with a 1% increment of momentary frequencies.

Prior to commencing the test, a functional test was performed on the EUT to ensure correct operation. During testing the EUT was monitored for any degradation in performance.

Test Set Up

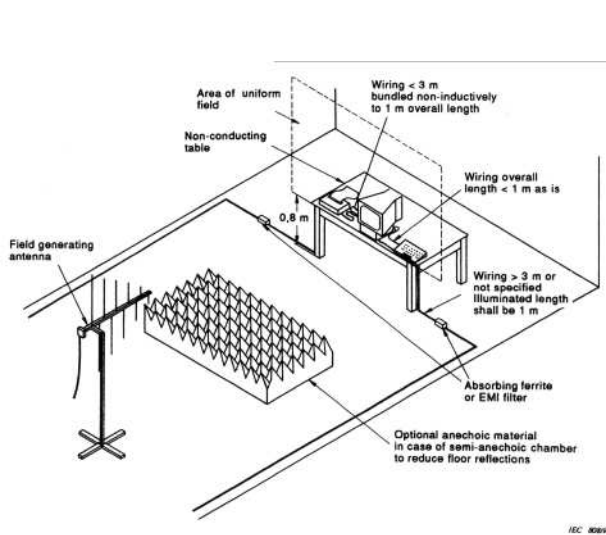
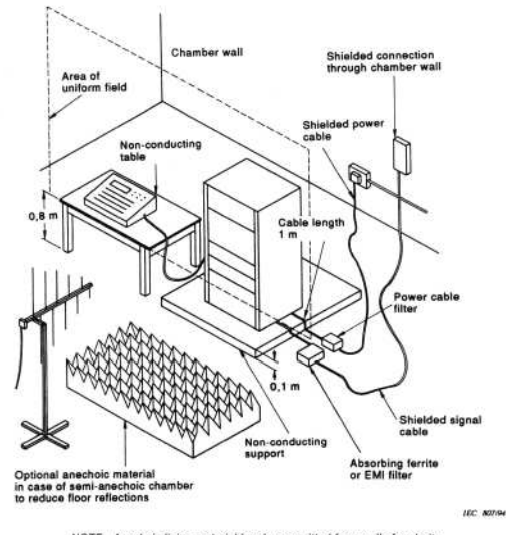

Table top equipment



Floor standing equipment

NOTE Anechoic lining material has been omitted from walls for clarity.

RF Radiated Field Immunity Test

G Tem

Objectives

To establish the performance of the equipment under test (EUT) when subjected to radio frequency electromagnetic fields.

Test Method

Tests were carried out in the G-TEM cell in accordance with the requirements of BS EN61000-4-3 : 1996.

The test field was 80% AM modulated with 1 kHz sine wave. The field frequency was swept under computer control with a 1% increment of momentary frequencies.

Prior to commencing the test, a functional test was performed on the EUT to ensure correct operation. During testing the EUT was monitored for any degradation in performance.

Test Set Up

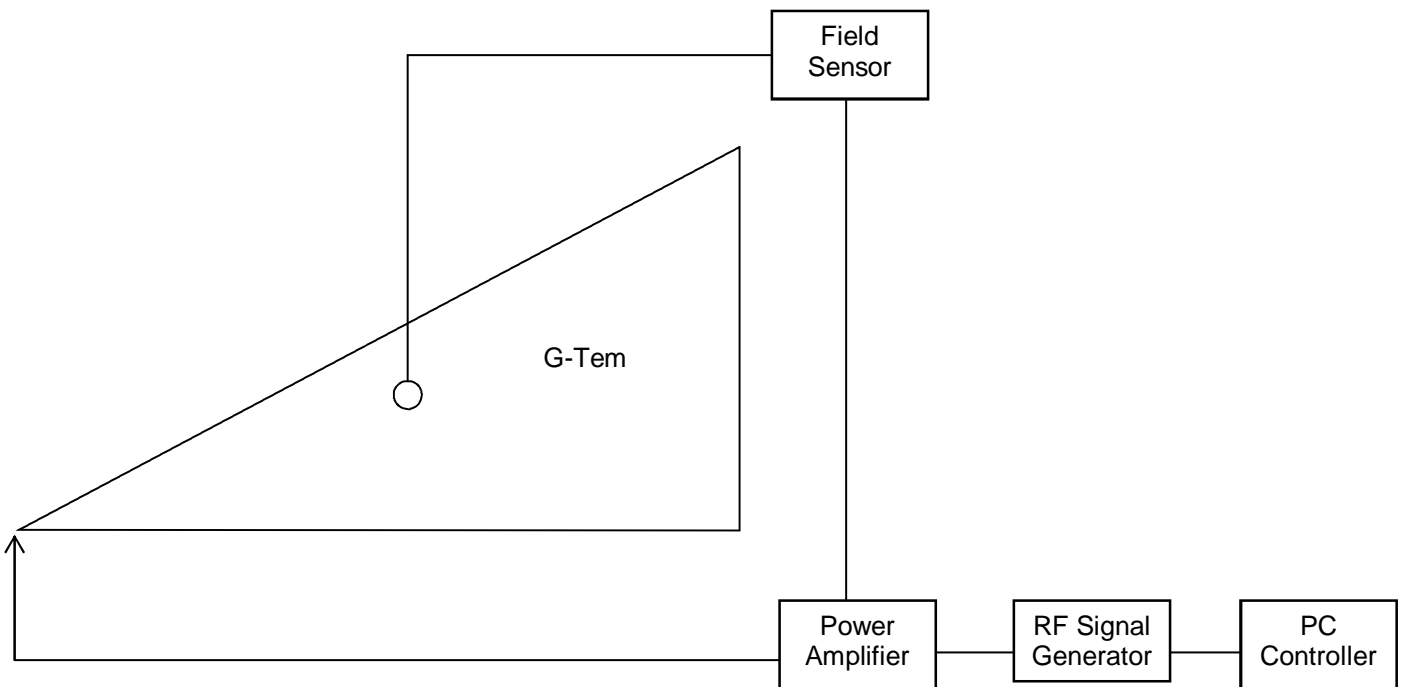

Surge Immunity Test

Objectives

To establish the performance of the equipment under test when subjected to high-energy disturbances on the power and interconnection lines.

Test Procedure ETS rpSURGE modula

Test Method

Tests were carried out to the applicable levels at test site 4 in accordance with the requirements of BS EN61000-4-5 : 1995.

The test surge short circuit characteristics were 8 us rise time and 20 us period.

Testing was under control of the Schaffner WinBEST EMC Software version 4.50.

Prior to commencing the test, a functional test was performed on the EUT to ensure correct operation. During testing the EUT was monitored for any degradation in performance.

Test Set-up

The surge immunity tests are set up in accordance with EN61000-4-5 1995 Section 7.

Test set-up for tests applied to EUT power supply

The surge is to be applied to the EUT power supply terminals via the capacitive coupling network (see figures 01, 02, 03 and 04). Decoupling networks are required in order to avoid possible adverse effects on equipment not under test that may be powered by the same lines and to provide sufficient 'decoupling impedance to the surge wave so that the specified wave may be developed on the lines under test. If not otherwise specified the power cord between the EUT and the coupling/decoupling network shall be 2 m in length (or shorter). To simulate the representative coupling impedances, in some cases additional specified resistors have to be used for the tests.

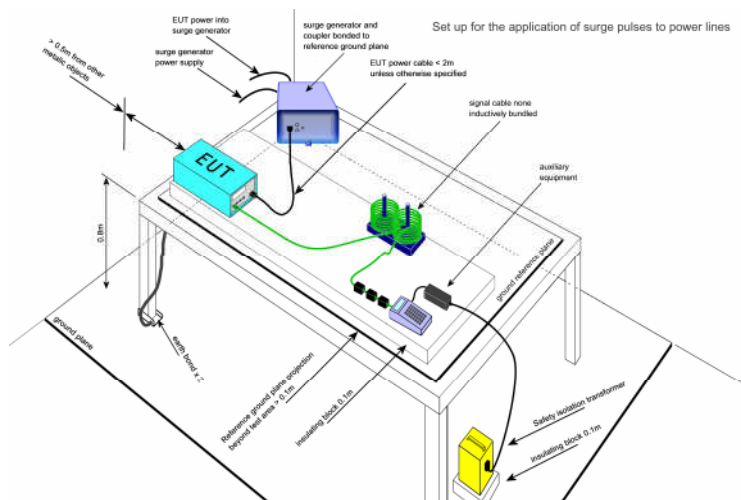

Conducted Immunity Test

Objectives

To assess the performance of the EUT to conducted immunity disturbances coming from intended radio frequency transmitters in the frequency range 150 kHz - 100 MHz.

Test Method

The test shall be performed with the test generator connected to each of the coupling and decoupling devices in turn while the other non-excited RF input ports of the coupling devices are terminated by a 50 Ω load resistor.

The frequency range is swept from 150 kHz to 80 MHz, using the signal levels established during the setting process, and with the disturbance signal 80% amplitude modulated with a 1 kHz sine wave, pausing to adjust the RF signal level or to switch coupling devices as necessary. The rate of sweep shall not exceed 1.5 x 10⁻³ decades/s. Where the frequency is swept incrementally, the step size shall not exceed 1% of the start and thereafter 1% of the preceding frequency value.

Prior to commencing the test, a functional test was performed on the EUT to ensure correct operation. During testing the EUT was monitored for any degradation in performance.

Test Set-up

Test set-up is in accordance with BS EN 61000-4-6 : 1996. The EUT is placed on an insulating support, 0.1 m above the ground reference plane. For table-top equipment, the ground reference plane may be placed on a table.

On all cables to be tested, coupling and decoupling devices shall be inserted. The coupling and decoupling devices shall be placed on the ground reference plane, making direct contact with it at about 0.1 m to 0.3 m from the EUT. The cables between the coupling and decoupling devices and the EUT shall be as short as possible and shall not be bundled nor wrapped. Their height above the ground reference plane shall be between 30 mm and 50 mm.

Immunity test to RF conducted disturbances

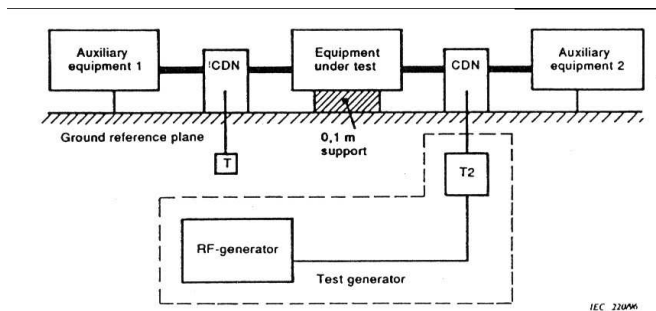

- T Termination 50 Ω
- T₂ Power attenuator (6 dB)
- CDN Coupling and decoupling network

IEC 22096

Magnetic Field

Objectives

To evaluate the immunity of the EUT when subjected to Power frequency magnetic fields related to the specific location and installation condition of the equipment.

Test Procedure ETS tpPwrFreqMag

Test Method

Tests were carried out to the applicable levels at test site 4 in accordance with the requirements of BS EN61000-4-8 : 1993.

The EUT was subjected to a magnetic field to the appropriate levels required by the applicable standard.

The EUT was placed within the magnetic loop and rotation to its three Axis.

Testing was under control of the Schaffner WinBEST EMC Software version 4.50.

Prior to commencing the test, a functional test was performed on the EUT to ensure correct operation. During testing the EUT was monitored for any degradation in performance.

Test Set-Up

The EUT is placed on a non magnetic GRP with the interposition of a 0.1 m thickness insulating support. All cables shall be exposed to the magnetic field for 1 m of their length.

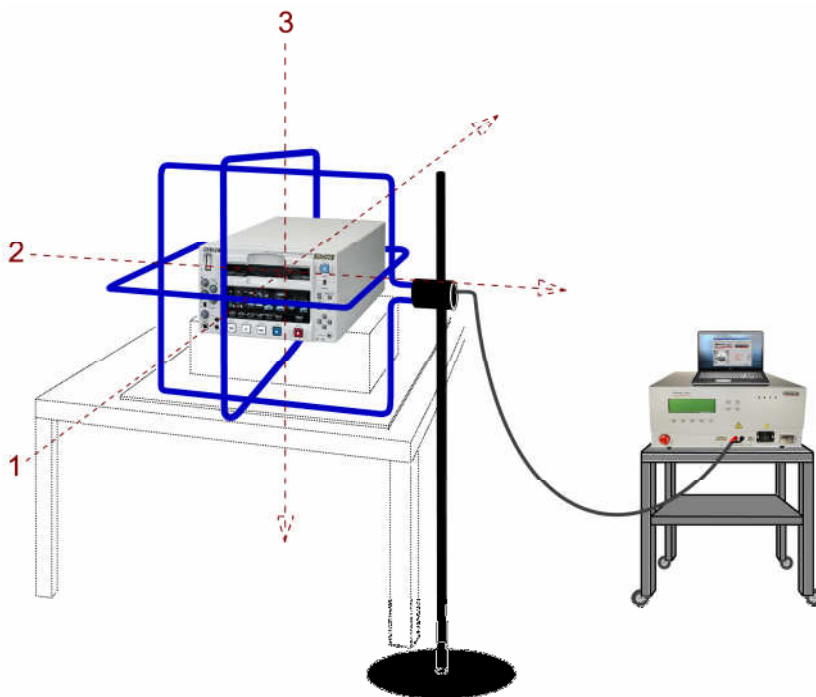

Voltage Dips/Interruptions

Objectives

To evaluate the immunity of the EUT when subjected to voltage dips short interruptions and voltage fluctuations.

Test Procedure ETSDips&Int

Test Method

Tests were carried out to the applicable levels at test site 4 in accordance with the requirements of BS EN61000-4-11 : 1994.

The supply voltage of the EUT was varied and disrupted to the appropriate levels required by the applicable standard.

Testing was under control of the Schaffner WinBEST EMC Software version 4.50.

Prior to commencing the test, a functional test was performed on the EUT to ensure correct operation. During testing the EUT was monitored for any degradation in performance.

Test Set-up

The test shall be performed with the EUT connected to the test generator with the shortest power supply cable as specified by the EUT manufacturer. If no cable length is specified, it shall be the shortest possible length suitable to the application of the EUT.

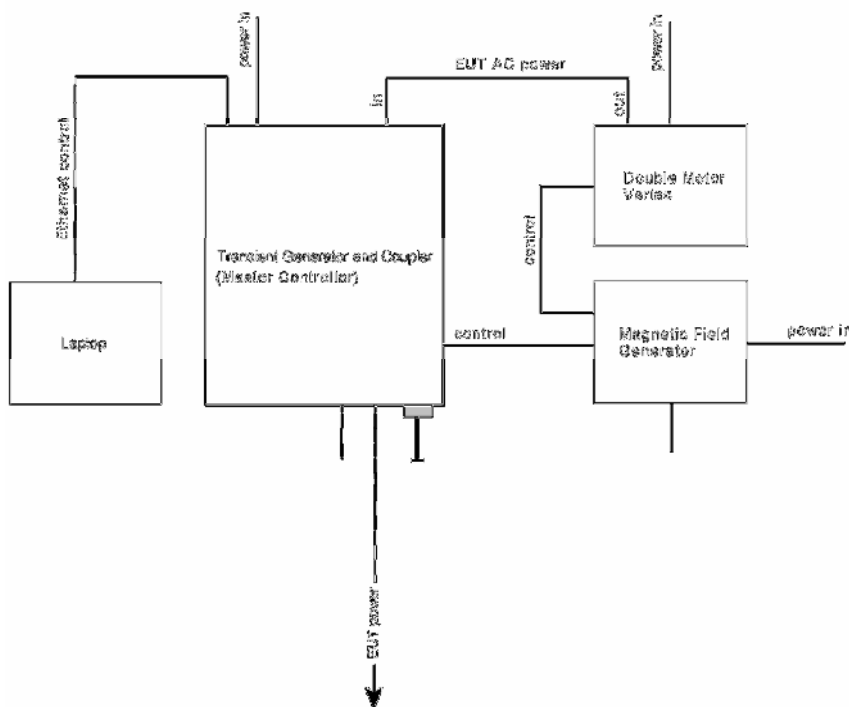

Acronyms and Abbreviations	
AV	Average
EFT	Electrical Fast Transients
EMC	Electromagnetic Compatibility
EMI	Electromagnetic Interference
ESD	Electrostatic Discharge
EUT	Equipment Under Test
HCP	Horizontal Coupling Plane
ITE	Information Technology Equipment
OATS	Open Area Test Site
PC	Personal Computer
QP	Quasi Peak
RF	Radio Frequency
VCP	Vertical Coupling Plane
RHS	Right Hand Side
LHS	Left Hand Side

COMPLIANCE NOTE

The test results documented in this report refer exclusively to the product (s) submitted for testing. On going compliance with the applicable standards is subject to manufacturers equipment being identical in design, construction and quality to the assessed sample. All product modifications must be evaluated for assessment of any impact on the EMC status.

To ensure continued compliance future retests may be necessary.

EU LABELING REQUIREMENTS

Products that have been found to comply with the applicable standards and meet the essential requirements of the EMC Directive 2004/108/EC, shall be identified with the CE mark.



The EMC directive is one of several EU directives for which the CE mark provides presumption of conformance. Compliance with the essential requirements of all applicable directives must be met before the CE mark can be legally applied.